

# Ergonomic requirements for dental equipment.

Guidelines and recommendations for  
designing, constructing and selecting dental equipment.

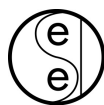

Prof O. (Oene) Hokwerda,  
dentist and dental ergonomist



J. A. J. (Joseph) Wouters,  
registered occupational assessor and  
ergonomist



R. A. G. (Rolf) de Ruijter,  
dentist and in training as dental  
ergonomist

S (Sandra) Zijlstra-Shaw B.D.S.,  
dentist

May 2006



Contents.

- 1. Introduction. .... 4
- 2. Significance of the requirements for dental equipment. .... 5
- 3. Legislation. .... 6
- 4. Use of standards. .... 7
- 5. Use of anthropometric data. .... 8
- 6. Kinematic chain for the eye-hand coordination of the dentist. .... 10
- 7. Visual aspects of the kinematic chain. .... 12
- 8. Maintaining the balance of the posture required to support the kinematic chain. .... 13
- 9. Survey ergonomic requirements for dental equipment. .... 14
- 10. Working stool dentist. .... 15
- 11. Patient chair for a sitting dentist..... 19
- 12. Dimensions of the patient chair for a sitting dentist..... 22
- 13. Support of head and neck by headrest and neck support. .... 29
- 14. Relation working field in mouth patient and upper body dentist. .... 32
- 15. Basis patient chair. .... 34
- 16. Patient chair for working standing. .... 35
- 17. Foot control dental unit. .... 41
- 18. Dental operating light..... 42
- 19. Using matt surfaces. .... 45
- 20. Positioning instruments with tubing (dynamic instruments)..... 46
- 21. Positioning hand instruments for the dentist. .... 49
- 22. Positioning instruments for the dental assistant. .... 50
- 23. Positioning spittoon..... 50
- 24. Principles for dynamic instruments to be used separately or in a unit..... 51
- 25. Use equipment by right and left handed dentists. .... 51
- 26. Screen (visual display terminal, VDT) related to dental equipment. .... 52
- 27. Infection prevention. .... 53
- 28. Equipment not fulfilling ergonomic requirements fully. .... 54
- Appendix. .... 55



# Ergonomic requirements for dental equipment.

## Guidelines and recommendations for designing, constructing and selecting dental equipment.

### 1. Introduction.

In this document ergonomic requirements are specified for dental equipment aimed at making it possible for dentists ranging from P5 woman ( $P_{(F)5}$ ) up to P95 man ( $P_{(M)95}$ ) to work without damaging their health. To this end the following references have been used:

- Directive concerning Medical Devices. European Medical Device Directive (MDD), 12 July 1993, 93/42/EEC.
- Directive concerning health and safety at work, 89/391/EEC.
- ISO Standard 6385 “Ergonomic principles in the design of work systems”.
- ISO Standard 11226 “Ergonomics – Evaluation of static working postures”.
- ISO Standard 9241-9 Ergonomic requirements for office work with visual display terminals (VDT’s) – Part 9: Requirements for non-keyboard input devices.
- DINED tables 2003 with anthropometric data for man and woman, which apply in Europe. TNO/Human Factors/Technical University, Delft, Faculty Industrial Design.

The following are amongst the many books which have been used as reference:

- Working Postures and Movements. Tools for Evaluation and Engineering. Editors Delleman NJ, Haslegrave CM and Chaffin DB. London, New York, Washington: CRC Press LLC, 2004. The book contains a review of recent research.
- Design-relevant characteristics of ageing users. Editors Steenbekkers LPA, Beijsterveldt CEM van. University of Technology, Subfaculty of Industrial Design Engineering. Delft: University Press, 1998.
- The Measure of the Man and Woman. Human Factors in Design. Designer Dreyfuss H, Drawings Tilly AR. New York: Wiley Roodveldt, 1997.
- Zahnärztliche Praxis- und Arbeitsgestaltung. Ergonomie als Grundlage der Leistungs- und Lebensqualität. Kimmel K. Köln, München: Deutscher Zahnärzte Verlag Däv-Hanser, 2001.
- Der Zahnarzt im Blickfeld der Ergonomie. Eine Analyse zahnärztlicher Arbeitshaltungen. Rohmert W, Mainzer J, Zipp P. Köln: Deutscher Ärzte-Verlag, 1988.
- Occupational Health Risks in Dentistry – Musculoskeletal Disorders and Neuropathy in Relation to Exposure to Physical Workload, Vibrations and Mercury. Thesis. Åkesson I. Lund: Department of Physical Therapy and Department of Occupational and Environmental Medicine, Lund Sweden, 2000.
- Perception. Rock I. New York, Oxford: Scientific American Books Inc, 1987. Distributed by Freeman and Company.

The goal is to define the functional man-machine system for the dentist on the basis of a product system analysis starting from human functions in relation to current anthropometric data and existing rules.

A draft of this document has been presented during the Annual Meeting of the European Society of Dental Ergonomics in Bensheim, Germany, on June 10 and 11, 2005, requesting comments on it.

## **2. Significance of the requirements for dental equipment.**

International dental literature shows that about 65 % of dentists, that means 2 out of every 3 dentists, have musculoskeletal complaints which vary in severity, but involve one or more of the following; discomfort, pain, hindrance in functioning and loss of working time. The risk of disability, whether partial or complete, as a consequence of either physical factors alone or a combination of mental and physical factors, is considerable. Muscle tension increases in relation to stress, so does the muscle load, moreover the physical load is often already high. Recently alarming data were published with respect to the occurrence of musculoskeletal pain experienced by dental students in San Francisco. The percentage of students experiencing this pain, measured from the first to the third year, rose to about 70 % and the persistence, duration and frequency of pain also increased. One of the conclusions is, that this may lead to serious physical disabilities later on. Furthermore, the number of woman entering the dental profession is increasing in most countries, and women are more prone to develop a variety of types of chronic musculo-skeletal pain than are man. Finally, recent research over the use of a pair of spectacles with prism segments showed that dentists who where able to sit upright because of the help they received from this optical accessory experienced a considerable reduction in both objective and subjective symptoms of musculoskeletal complaints, within a period of 4 weeks.

The reasons for the authors to work out the “Requirements” were:

1. the frequent confrontation with musculoskeletal problems and disability experienced by dentists wherein which the ergonomic limitations of dental equipment played a distinct role;
2. the above mentioned experience at a dental school in the USA which demonstrated an increased incidence of musculoskeletal pain.
3. legislation and rules requiring that equipment be available with which it is possible to work without damaging the operators health. However, so far, no ergonomic criteria were defined for this equipment. Additionally, the CE mark is used without a sufficiently good relation to the relevant ergonomic criteria;
4. standards are made without sufficient information about ergonomic aspects;
5. an increasing number of dentists, hygienists etc, work as employee(s) and, as a consequence, frequently have to work with equipment that does not fit the required way of working and/or individual characteristics;
6. dental equipment has to be bought increasingly by decision makers for people other than themselves to work with. (Dental equipment is increasingly bought by decision makers rather than the people who eventually have to work with it)

It can therefore be seen that the authors have taken the initiative to work out the “Ergonomic requirements for dental equipment” as an overture for the correct application of existing legislation, rules and CE mark, as a basis for the development of a hallmark which many dentist are requesting and finally to prevent liability problems that can be foreseen in the future if no clear ergonomic criteria are used for the production and selection of dental equipment.

Prof Oene Hokwerda has done pioneering work for the benefit of the development of the “Requirements”, in close cooperation with the 3 other authors and this has been carried out under their own volition. However, the initiating reason for this study was the request of Sirona, host of the Annual Meeting of the European Society of Dental ergonomics (ESDE) on June 10-11 2005, in Bensheim, Germany, who wished to discuss the principles for the development of ergonomic equipment in the future.

This information is therefore provided for everybody who is associated with the use of dental equipment. The requirements for dental equipment are important for:

1. designers and producers of equipment, to be able to meet the standards for working without damaging the health of the users, according to EU legislation and in relation to the CE mark;
2. dentists for judging and selecting dental equipment;
3. ISO and CEN in the framework of developing new standards;
4. European Society of Dental Ergonomics to promote the use of the “Requirements” and to discuss the many topics that still have to be fully developed;
5. team practices, institutions, dental schools, policymakers etc. as a guideline for selecting dental equipment in a well considered way;
6. dental associations and insurance companies to be able to support dentists with respect to preventing occupational diseases;
7. creating a basis for training dental students and dentists to work without damaging their health;
8. dental depots when providing information for dentists.

### **3. Legislation.**

In the EU there is more and more emphasis being placed on health and safety legislation . In the Directive of the EU concerning Medical Devices, general requirements are laid down directed at health and safety protection for patients and users with regard to the use of medical devices. The following examples show a few of these general requirements.

Art. 8.1. The devices and manufacturing processes must be designed in such a way as to eliminate or reduce as far as possible the risk of infection to the patient, user and third parties. The design must allow easy handling and where necessary, minimize contamination of the device by the patient or vice versa during use.

Art. 9.2. Devices must be designed and manufactured in such a way as to remove or minimize as far as possible the risk of injury, in connection with their physical features, including the volume/pressure ration, dimensional and where appropriate ergonomic features. Etc.

Art. 12.7.3. Devices must be designed and manufactured in such a way as to reduce to the lowest possible level the risk arising from the noise emitted, taking account of technical progress and of the means available to reduce noise, particularly at source, etc.

The European Directive concerning health and safety at work is directed to:

1. taking care of the protection of health and safety of employees as to protect them against and prevent occupational risks;
2. basing the choice of work equipment on the specific working conditions and hazards existing;
3. providing workers with adequate information about a good use of it.

This European directive serves as a basis for being developed into national laws.

A growing number of dentists etc. in dental practices are now working as employees and this law also applies to them.

## 4. Use of standards.

The standard ISO 6385 “Ergonomic principles in the design of work systems” contains among other things the following “General guiding principles”. This is a selection of the relevant aspects.

### 4.1 Design of work space and of work equipment.

#### 4.1.1. Design in relation to body dimensions.

The design of the work space and work equipment shall take into account constraints imposed by body dimensions, with due regard to the work process. The work space shall be adapted to the operator. In particular: a) The working height shall be adapted to the body dimensions of the operator and to the kind of work performed. Seat, work surface and or desk (tray) should be designed as a unit to achieve the preferred body posture, namely trunk erect, body weight appropriately supported, elbows at the side of the body, and forearms approximately horizontal.

b) The seating arrangements shall be adjusted to the anatomical and physiological features of the individual.

c) Sufficient space shall be provided for body movements, in particular of the head, arms, hands, legs and feet. Etc.

4.1.2 Design in relation to body posture, muscular strength and body movement. The design of the work shall be such as to avoid unnecessary or excessive strain in muscles, joints, ligaments, and in the respiratory and circulatory systems. Strength requirements shall be within physiologically desirable limits. Body movements should follow natural rhythms. Body posture, strength exertion and body movement should be in harmony with each other.

#### 4.1.2.1. Body posture.

Attention shall be paid primarily to the following:

a) The operator should be able to alternate between sitting and standing. If one of these postures must be chosen, sitting is preferable to standing; standing may be necessitated by the work process.

c) Body postures should not cause work fatigue from prolonged static muscular tension. Alternations in body posture shall be possible.

4.1.2.3 Body movement. a) A good balance shall be established among body movements: motion shall be preferred to prolonged immobility.

c) Movements with great accuracy requirements shall not entail exertion of considerable muscular strength.

### 4.2 Design of the work environment.

d) Lighting shall be such as to provide optimal visual perception for the required activities.

Special attention shall be paid to the following factors: luminance, colour, distribution of light, absence of glare and undesirable reflections, contrast in luminance and colour, and age of operators.

e) In the selection of the colours for the room and for the work equipment, their effects on the distribution of luminances, on the structure and quality of the field of vision, and on the perception of safety colours, shall be taken into account.

Here ends the selection of the General guiding principles from the standard.

The standard requirements as stated in Standard ISO 11226 “Ergonomics – Evaluation of static working postures” can be summarized as follows:

1. sit in an active, symmetrical posture upright. The upper body can be bent forward from the hip joints maximally 10-20° but bending sideward/laterally and rotations must be avoided. The head can be bended forward maximally 25°.

More extreme positions and movements of hands and arms including raising the shoulders



should be avoided.

Observation: bending forward with the upper body more than  $10^\circ$  is irresponsible for dentists, as a result of the unfavourable static load that this posture brings.

2. to achieve a dynamic way of working, the dentist should move as much as possible during patient treatment in order to alternate the load and relax the muscles and vertebral column.
3. ensure a firm muscle corset by sport and or movement outside office hours: this is particularly important for recovery of the burdened muscles and enlarging the muscle strength, to be better able to maintain a correct posture. This issue will not be dealt with in this document.

The content of these standards is worked out. for the dentist in the following chapters. This is done with the help of the following book “Working Postures and movements. Tools for Evaluation and Engineering.”

## **5. Use of anthropometric data.**

The DINED anthropometric data, 2003, and “Design-relevant characteristics of ageing users” have been used to carry out the survey of requirements for designing dental equipment. The data regarding the P5 female dentists ( $P_{(F)5}$ , see 5.1) and P95 male dentists ( $P_{(M)95}$ , see 5.2) were used as limiting values, so that equipment based on the use of these data are suitable for dentists with anthropometric data between the P5 and P95 data. These data have also been used for the  $P_{(F)5}$  female and  $P_{(M)95}$  male patients. When data were not available in the above mentioned books data have been derived from “The measure of the Man and Woman. Human Factors in Design” where they are provided for P1 and P99 persons. Sometimes data had to be calculated on the basis of available data and additional clinical observations were necessary to verify data. When necessary and possible, data for the  $P_{(F)1}$  and  $P_{(M)99}$  dentist and patient were also used, so that as far as possible all situations could be accommodated.

A particular problem is that a Px dentist does not have Px dimensions for all body parts. A certain variation in dimensions is possible, regarding e.g. the upper and lower arms, the stomach and the height above the operating stool resulting from the diameter of the thigh. We realize that we do not apply the criterion “Design for all” which is frequently used, nowadays, as a guideline to ensure that the results are universally inclusive. By using the data we have, the 5 % shortest female dentists and the 5 % tallest male dentists - and the patients who fall outside this range- are not yet considered within the requirements for the construction of dental equipment. We know that discussions are going on in the EU about a “Design for All” (in the USA called Universal Design), to include all people, and that the discussion is carried out on the basis of anti-discrimination or equal status for all citizens laws. This may become a rule in the future.

(Continue reading on the next page)

But using the anthropometric data for  $P_{(F)5}$  and  $P_{(M)95}$  dentists we must try to achieve a broader accessibility for the growing number of smaller and taller dentists.

5.1 A P5 female dentist ( $P_{(F)5}$ ) has a length of 155.7 cm. This length is the upper limit of the 5 % of woman with the shortest length and is thus the lower limit of our study.

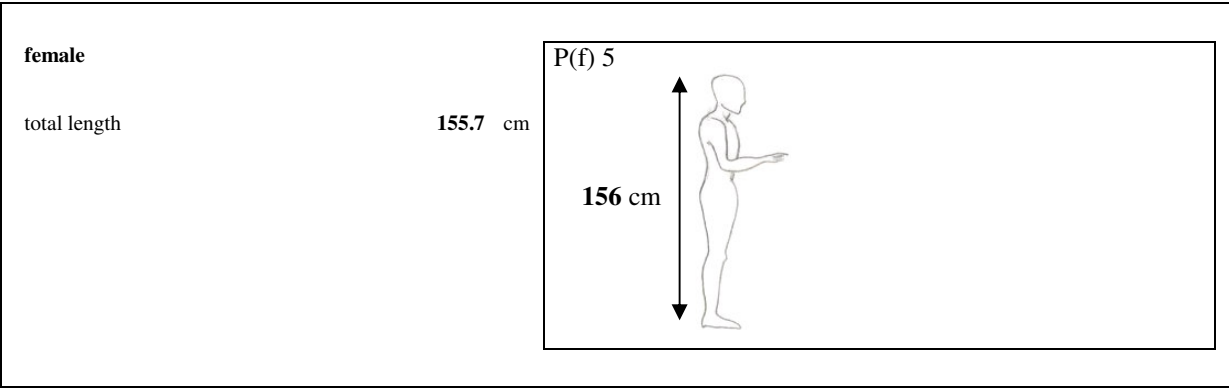

fig. 5.1

5.2 A P95 male dentist ( $P_{(M)95}$ ) has a length of 195.8 cm. This length is the lower limit of the 5 % of men with the tallest length and thus the highest limit of our study.

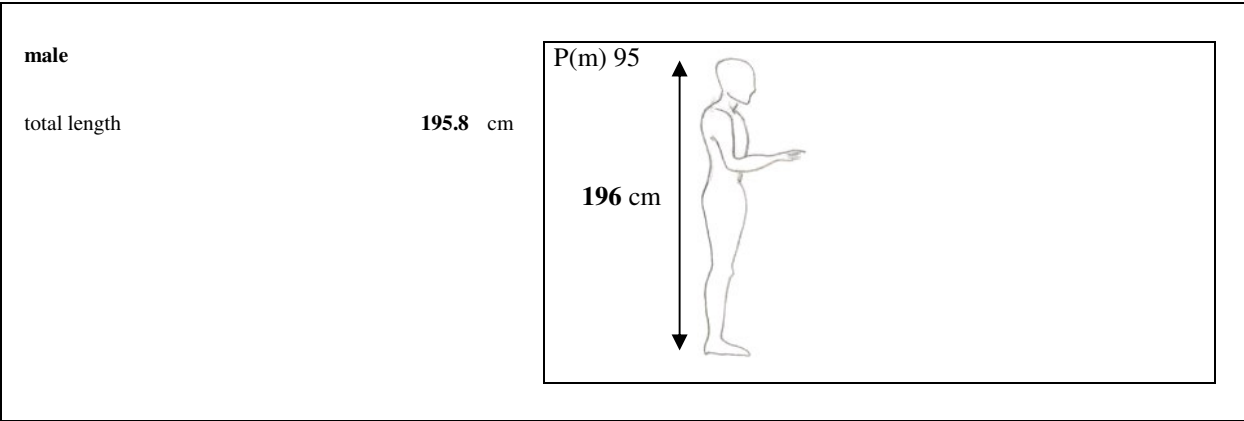

fig. 5.2

## 6. Kinematic chain for the eye-hand coordination of the dentist.

When dentists perform actions inside or outside the mouth of the patient they manipulate instruments with their fingers and hand. This requires appropriate eye-hand coordination by means of a kinematic chain consisting of a number of body segments that have to move in an optimal coherence in the space before the upper body of the dentists to carry out the different dental tasks. This kinematic chain consists of the fingers, hands, lower and upper arms, upper body, shoulders, neck and head which incorporates the viewing direction of the eyes. In order to be able to carry out the different tasks visual, tactile and proprioceptive perception is necessary. The information gathered is processed and the output generated, directed at steering the locomotion of the kinematic chain, with the hand and fingers at the end of the chain for performing the tasks. The way this is organised, and the working field is positioned, must make it possible for the kinematic chain to function in an optimal manner. That is, so that the different parts can function as much as possible (ample) within the limits of a healthy posture. The way in which this is possible depends on anatomical dimensions. The man-machine system of the dentist is based on the requirements and limits with respect to a healthy posture, positioning the working field in the mouth straight before the upper body and placing the instruments at an appropriate working height, distance and position for grasping.

As stated before (chapter 4, general principals with reference to ISO 11226), the principle for a sitting working posture is a stable, active posture with the upper body symmetrically upright. To be able to adopt this posture three basic principles with respect to positioning the working field in the mouth of the patient have to be met.

1. To position it in the symmetrical plane in order to adopt a symmetrical working posture. (The symmetrical plane is the mid-sagittal plane that divides the upper body vertically in two equal parts).
2. To turn the head of the patient around three axes, in three directions: (forward/backward, lateroflexion to the right or left and rotation around the length axis of the head) so that the working field in the mouth becomes directed toward the viewing direction of the dentist. In this way the surface of the tooth to be treated becomes positioned, as near as possible, parallel with the front of the head of the dentist. The goal here is to be able to look, as near as possible, perpendicularly on it, otherwise the eyeballs steer the posture to try and achieve this end, which results in an unfavourable, mostly asymmetrically position.
3. To establish the right height of the working field in the mouth, for which the lower arms are lifted minimally 10° (small dentists) and maximally 25° (tall dentists). Lifting of the arms is related with the distance between working field and eyes or spectacles. This is 35-40 cm, can be slightly more in case of very tall dentists.

The same principles apply for working standing.

The kinematic chain of the dentist is as follows, taking into account the principles for the working posture and placing the working field. (*This survey is based on available data.*

*Further investigation is necessary).*

1. Adopting a symmetrical posture upright (*by positioning the working field in the symmetrical (= mid-sagittal) plane of the dentist.*
2. Further characteristics or limits regarding sitting in a healthy way in a static posture, are the following.
  - The head (on average weighing 4.5 kg) is bent forward, high in the neck, 15-20°, maximally 25°.
  - The breastbone is pushed forward and upward and the abdominal muscles are strained lightly.

- The upper arms are held against the upper body, about 10° to maximally 15° forward (*so that the shoulders are not turned forward (protraction) in a strained position; and the upper arms maintain good contact with the upper body and do not lose it so that the support of the arms gets lost*).
  - No rotations and bending sideward of head and upper body.
  - The upper body is bent maximally 10° by turning at the hip joint, but bending forward should preferably be restricted in connection with the static load and a certain reduction of the agility of the body. Furthermore, the less the load on the back is, the less will be the shortening of the vertebral column, by which the muscle tension increases.
  - When working in a static bent posture and particularly if the shoulders are raised or brought into protraction, a narrowing of the costicoclavicular gate arises. As a consequence of this pressure arises on the nerves and blood vessels that pass through, resulting in a diminished circulation.
  - The angle between upper and lower legs is 110° or a little more to obtain a tilting of the pelvis forward just like in the standing posture of the human being.
  - The upper legs are spread maximally 45°.
- (For a standing posture similar considerations apply).
3. Movements of the upper arms are minimized as much as possible sideward until 15-20° and forward until 25° to avoid raised shoulders; and take place within the field of vision (see 7.1). Instruments will be picked up and returned with a simple, natural way of gripping.
  4. The lower arms are lifted minimally 10° (*lower than 10° results in the upper body bending forward*) and maximally 25° (*not higher because than the working field becomes too near to the upper body by which the head and the top of the upper body are forced to bend forward while the back as a whole is bending backwards. Furthermore the upper arms loose their contact with the upper body and so their support; and the shoulders are raised by lifting the arms that high, resulting in a considerable increase of the static muscle load in the kinematic chain*). An angle of about 90° between lower and upper arm seems to fit the kinematic chain best. The fingers reach then further before the upper body than with a smaller angle and this relates to a smaller bending of the head. The distance between working field and eyes or spectacles is between 35-40 cm. This distance determines the working height (*and is based on an optimal coherence of the parts of the kinematic chain. When adopting a correct working posture the working distance turns out to be between 35-40 cm except for tall dentists. When the distance becomes too high a correction with spectacles has to be advised*).
  5. The lower arm(s) must rest on the fourth and fifth finger in and/or outside the mouth, preferably at some distance from each other (for more stability) in order to support the weight of the lower arm. When possible the ball of the hand is resting on the cheekbone. (In this way an optimal relief of the muscles and stability for manipulating instruments arise).
  6. More extreme movements and positions of hands and arms have to be avoided.

Summary. The muscles for fixation of the working posture have to be loaded as little as possible in order to carry out the fine mechanical actions the dentist has to perform; and movements have to be restricted with respect to reach.

A stable, active posture is the key principle, and postures and movements outside the limits of a healthy posture have to be avoided. Variations are possible between the ideal posture and the limits of a healthy posture. However, the more one approaches the limits the greater the load on the muscles, vertebral column etc. becomes and therefore the chance of fatigue also increases; in the long run this also produces a greater risk of musculoskeletal complaints,

depending on individual conditions. This particularly applies to the combination of bending forward  $25^\circ$  with the head, and  $10^\circ$  with the upper body.

As stated before, as much movement as possible has to be built into the method of working during patient treatment in order to produce a regular relief of the static loaded muscles, joints, ligaments and vertebral column, and to create a dynamic procedure, for a dynamic, symmetrical posture.

## 7. Visual aspects of the kinematic chain.

The following visual principles are important.

1. Instruments have to be arranged within the field of vision, i.e. within an angle of  $30^\circ$  to both right and left of the symmetrical = mid-sagittal plane of the dentist. This allows the dentist to pick up instruments and return them with small movements and without turning the head away. This in turn leads to a tiring adaptation of the eyes, *resulting from the movement of the eyes, away from the level of illumination (=luminance) in the mouth, to a lower lighting level in the place of the instruments and later again to the higher illumination in the mouth.* This also leads to differences between accommodation of the eyes in both situations.
2. The dentist must be able to look, as much as possible, perpendicularly on the working field in the mouth of the patient in his symmetrical plane. This is due to the fact that the eyes steer automatically here and force the body to adapt a posture in which the eyeballs obtain the best position for perception (for a projection of the stimuli on the fovea for seeing well). When the working field is not placed in the right position for a proper posture, rotations of the eyeballs lead to adapting the posture - by bending forward and sideward and rotations of the body - so that the best possible position of the eyeballs can be reached.
3. If the working field is not placed in the symmetrical plane of the dentist the following consequences occur;
  - a difference in angle of convergence comes into being between right and left eye, resulting in a difference of muscle activity between both eyes leading to a greater fatigue within the eye muscles.
  - because of this, and as a consequence of the differences in distance of both eyes to the working field, a difference in straining of the eye muscles to the right and left of the eyeballs is produced by accommodation. The result is that one side of an eyeball is pulled a little more convex and the other side a little more elliptical. This affects the bending of the lenses. The creation of an image in the brains is consequently different in both eyes.
  - the amount of light (luminances) reaching both eyes may differ because different images/surfaces are observed by right and left eye. These differences result in a different adaptation occurring in each eye (i.e. a suction cannula coming from the left that is observed stronger by the left eye), resulting in differences in visual acuity between right and left eye. The greater the differences in luminance the stronger the effect.
4. The light beam of the dental operating light has to be positioned approximately parallel (deviating maximally  $15^\circ$ ) to the viewing direction in order to obtain shadow free lighting in the mouth i.e. a good balance between lighting in the working field and the mouth as a whole. The effect of this position is that the fatigue forming shadows behind the teeth, lips and cheek, below the hand and on and around the working field are avoided.

## **8. Maintaining the balance of the posture required to support the kinematic chain.**

The above description stated how a stable and active posture of the dentist must interact with the environment to maintain a dynamic balance. This is achieved by a coherent functioning of the following physiological systems.

1. The body's inherent horizontal awareness is steered by the viewing direction of the eyes, which is directed at maintaining the body upright, by positioning the bi-pupillar line of the eyes horizontally. This happens by means of orientation on horizontal and vertical planes such as floor/horizon and walls.
2. The organs of balance.
3. The proprioception, i.e. the perception of the position of the body in the space by observing the load of the posture by muscles, tendons and joints.
4. The steering of the movements of the body by high cervical stimuli in the medulla oblongata.

When a dentist maintains an unfavourable asymmetrical posture during long periods not only does the programming of the posture by the proprioception etc. become disturbed but there are also pathological changes induced within the tissues (and this is observed only when pain- as a consequence - is felt). Furthermore the visual perception, as described in the previous chapter, leads to strong visual fatigue and contributes to arising of headache together with a far forward bending of the head.

Summary. A dentist needs to work in a stable, active posture, symmetrically upright, making only small movements with the arms, avoiding raising the shoulders. In order to achieve this the working field has to be placed in the symmetrical plane of the dentist, at the right height and directed onto the field of vision so that he/she is able to look as much as possible perpendicularly upon it. The instruments should then be positioned at working height, within the field of vision with an angle of 30° to the right and the left. This results in the dentist being able to grasp the instruments in a natural way and so avoids more extreme movements of hands and arms. Additionally the beam of the dental operating light should be approximately parallel to the viewing direction of the dentist. Finally a dynamic method of working should be applied.

## 9. Survey ergonomic requirements for dental equipment.

In the following chapters the ergonomic requirements for the different parts of dental equipment are worked out on the basis of the ergonomic framework explained in the previous chapters. This is an extensive survey and it is a unique approach because this is the first time that requirements for dental equipment have been based on a thorough analysis of the physiological functions of the user, the dentist. When necessary, short explanations are given (*in italics*) which are related to the information provided in the first 8 chapters of this document.

The anthropometric data and ergonomic requirements are based on research data. These are used together with practical expertise, so that an evidence based approach is used within the limits of the available knowledge. However, the translation in dimensions for parts of the equipment may require further consultation, for example with respect to the technical possibilities, in order to realize the requirements to a sufficient extent. When no exact data are available this is stated. In the appendix "Survey subjects for which more empirical data are required" many subjects are stated for which further information must be gathered.

Everybody who is able to provide more documented information is invited to send this to the authors. Comments or elaborations are also welcome.

Considering the different data that can not be exactly calculated, it becomes clear that further research into the working situation of the dentist together with anthropometric data will be of great importance for obtaining a better insight. For this purpose financial support is needed from industry and/or the EU. Prof N.J. Delleman (Paris, Soesterberg, NL), an expert in this field of research, would be very capable of carrying out such a project.

Summary. The requirements for the different parts of dental equipment are reproduced or indicated below. All these parts have to function as an entity in connection with each other. This represents the functional man-machine system for the dentist. It starts with human functions in relation to current anthropometric data and existing rules. The patient is included in relation to the working field in his mouth, a comfortable manner of being treated on the patient-chair and the way of using the dental operating light.

Finally to underline the importance of designing dental equipment on the basis of the worked out requirements we quote Åkesson who puts forward the following propositions in "Occupational Health Risks in Dentistry- Musculoskeletal Disorders and neuropathy in Relation to Exposure to Physical Workload, Vibrations and Mercury":

"Thus, anthropometric considerations, equipment with good ergonomic characteristics and flexibility are requirements which must be adequately recognized in the design and layout of the dental operatory. Proper ergonomic arrangements in the workplace and in equipment with optimal and individual flexibility are of crucial importance to the dentistry profession.

In this vision demanding work, lighting of the oral cavity is also of particular importance, because it determines the ability of the operator to see the working area. Furthermore, visual comfort strongly influences the posture of the head and trunk during the treatment of a patient. Reach and manipulative-demands also strongly influence the adopted posture and the positions in the upper extremities.

Training and instructions in ergonomic principles are very much needed from the start of the studies in dentistry and should also be followed up continuously."

## 10. Working stool dentist.

- 10.1 The minimum angle between upper and lower leg has to be  $105^\circ$ , however, we take  $110^\circ$  as a basis to be sure that the pelvis is tilted forward. The angle of  $110^\circ$  can also be a little higher. *Sitting with an angle of  $110^\circ$  or a little higher between lower and upper legs is necessary for the correct position of pelvis and spinal column to stimulate an active, position of the body, upright, so that a correct anatomical posture – comparable with standing - is obtained; this is the least burdensome posture. By doing so moving and changing of the sitting position with the chair is also easier (necessary for a dynamic working style) and more space becomes available above the thighs for positioning patient and back with the headrest of the patient-chair above these. Finally, sitting down or standing up becomes more comfortable.*
- 10.2 Any angle between upper and lower legs requires a seat design that differs from the usually nearly horizontal seat. The dimensions of the seat have to make it possible to sit without pressure on either the backside or thighs, therefore the dentist needs to sit with sloping down thighs. The seat is divided in 2 parts for obtaining a balanced sitting posture: a horizontal part at the rear for supporting the buttocks with a minimal length of 15 cm (= *the maximal distance between tuberosities ischii and backside of the body*); and an oblique front part declining  $20^\circ$  (in relation with a horizontal plane) for an equal support of the thighs. With a movable front part, an angle of more than  $110^\circ$  between lower and upper legs is possible.

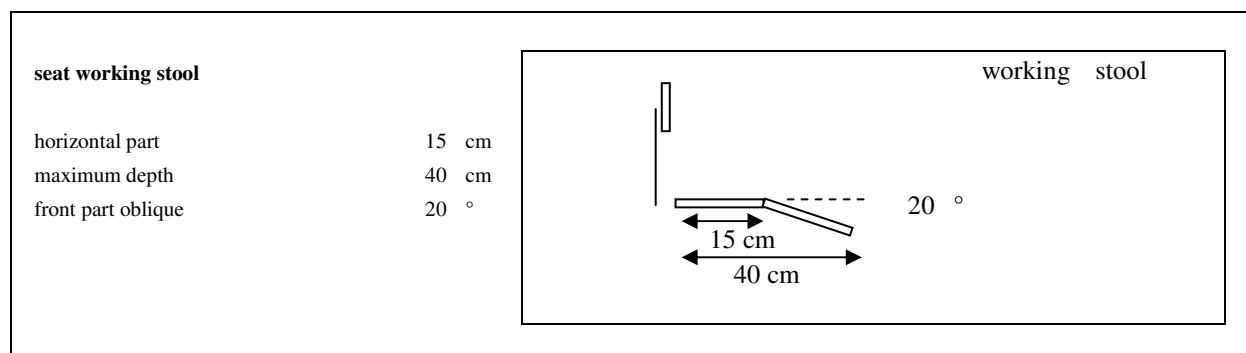

fig. 10.2

- 10.3 A slight inclination, of maximally  $6-8^\circ$ , in an oblique position, can be used to encourage an active sitting posture with the required degree of lordosis. A greater inclination will result in a tendency to slip forwards. *A seat declination of  $6-8^\circ$  does not lead, on its own, to the required  $110^\circ$  angle between upper and lower legs.*
- 10.4 The sides of the seat should not go up because, by doing so, the sides of the buttocks with their muscles are lifted upwards and this reduces the fixing of the pelvis, particularly when the pelvis is not well supported.



10.5 The maximum depth of the seat shall be 40 cm and the width 40 with a maximum of 43 cm.

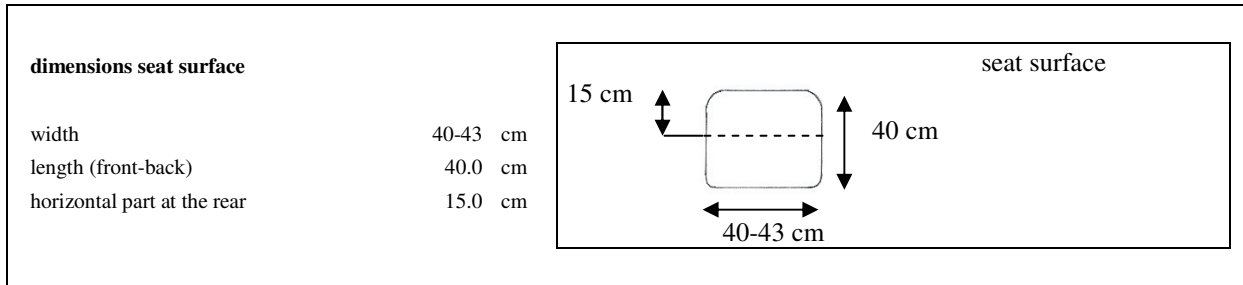

fig.10.5

10.6 The minimum sitting height for a P<sub>(F)</sub>5 dentist will be 46.9 = 47 cm (*height shoe 2 cm, length lower leg 37.7 cm and finally the effect of an angle of 110° between lower and upper leg on raising the sitting height = 7.2 cm*).

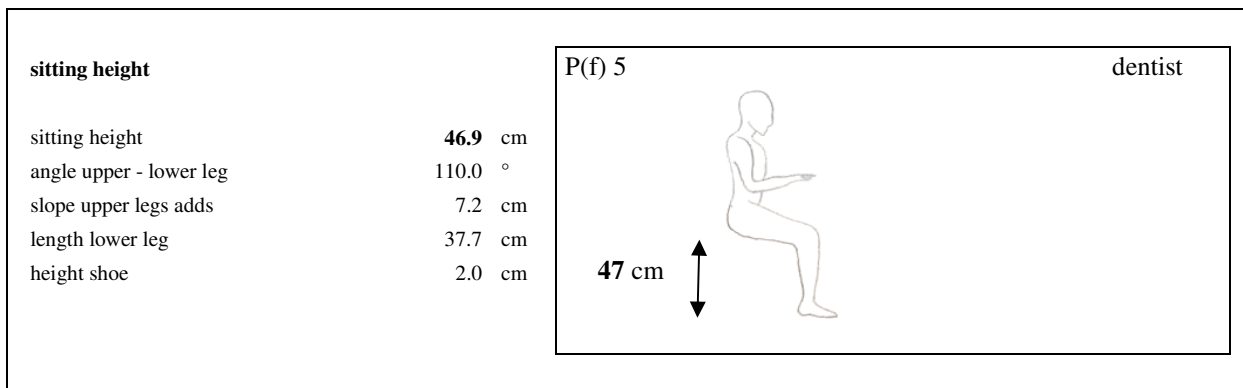

fig. 10.6

10.7 The maximum sitting height for the P<sub>(M)</sub>95 dentist will be 62.8 = 63 cm (*height shoe 3.5 cm, length lower leg 49.1 cm and finally the effect of an angle of 110° between lower and upper leg on raising the sitting height = 10.2 cm*).

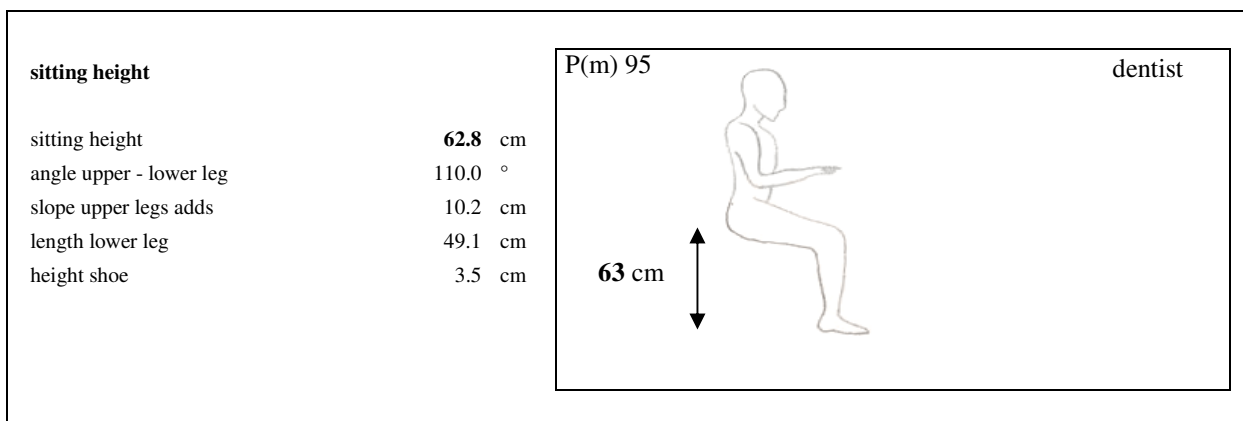

fig. 10.7

10.8 Conclusion: the range of height adjustment of the seat should be between 47 and 63 cm.

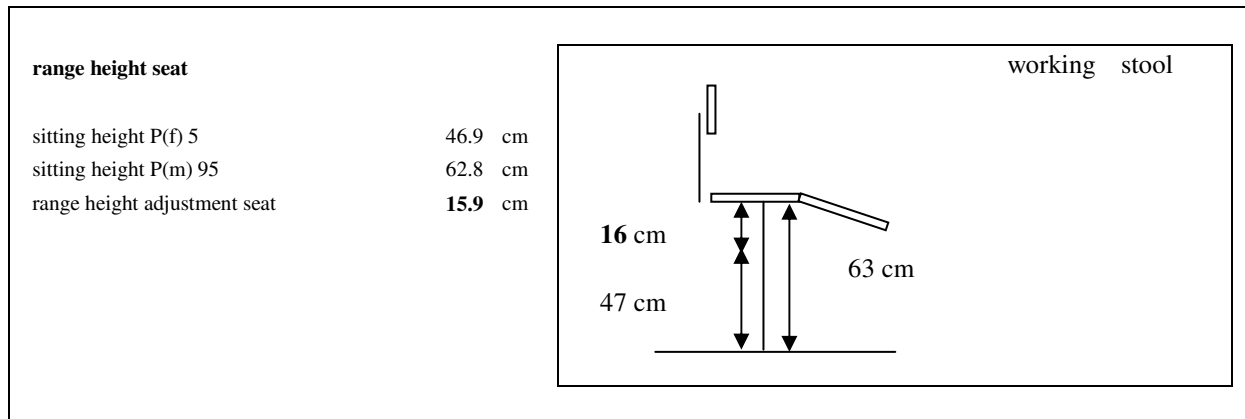

fig. 10.8

10.9 In order to support the vertebral column, a lumbar support of 10 to 12 cm high is needed at the top of the backside of the pelvis that is adjustable vertically from 17-22 cm and for very tall dentists to 24 cm. *N.B. This is the only place where support is required.*

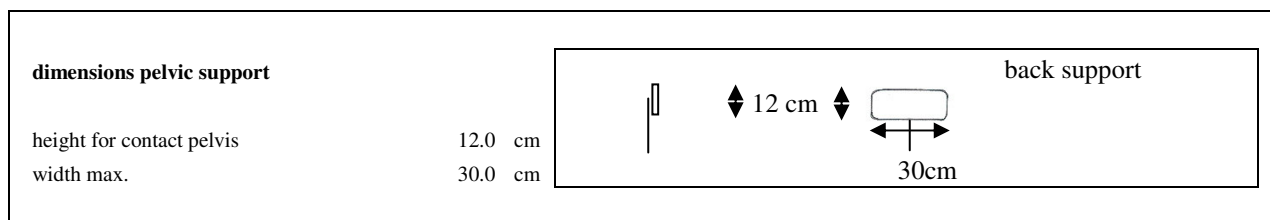

fig. 10.9 and fig. 10.11

10.10 The seat also needs to be horizontally adjustable to maintain the lordosis position (*the natural forward bending of the lumbar spine*) of the dentist's back, and so that the dentist can sit symmetrically upright in a stable sitting posture. *No data regarding the range required for a horizontal adjustment are available.*

10.11 The pelvic support should not exceed a width of 30 cm, otherwise it inhibits free movement of the arms and working stool.

10.12 The pelvic support is elastic over a very short distance of 1-2 cm (*no exact data are available*) and can rotate around a horizontal axis with an angle of 25° upwards and downwards (*no exact data are available*), while the upholstery should be flexible enough to tolerate being depressed. *This is necessary for adaptation to the curvature of the back horizontally and vertically; and to give more flexibility for moving with the upper body.*

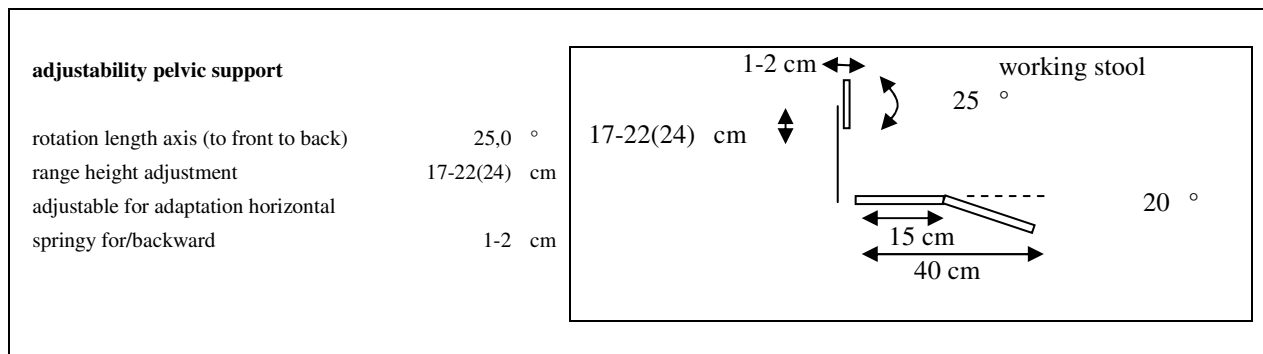

fig. 10.12

10.13 It must be impossible for the back to adopt a C- shape, that is a backwards rounded back, by adjusting the pelvic support. Support needs to be provided because this is an unfavourable posture with a high load on the structures of the spinal column (*intervertebral disks and ligaments*). One may sit upright in an active sitting position without support of the pelvis, but as soon as the back muscles are tired a rounded back is created, so that support of the pelvis is needed to remain seated upright.

10.14 While sitting in a working posture, there should be no contact between the pelvic support and the back musculature on either side of this pelvic support *because this disturbs a good sitting posture*. But for stretching, relaxing or leaning backward the pelvic support may continue upward, and also a little backward, so that contact may be brought about with the back by leaning backwards.

10.15 The upholstery of the seat has to be sufficiently hard with a roughened surface. It has to be firm, depressing only slightly. The problem here is that the precise result depends upon the weight of the dentist. If the upholstery is too soft it allows the pelvis to move into an incorrect and unstable position and is tiring. (*Further data are necessary*). A smooth surface stimulates slipping away. The height adjustment is related to the extent to which the upholstery is depressed by the weight of the dentist.

10.16 If armrests are considered desirable, 2 armrests are needed. They should be continuously adjustable to support both elbows at the proper height to avoid lifting of the shoulders and sitting asymmetrically. And also adjustable in a horizontal direction, while the form has to surround the lower arms slightly to be able to hold the contact of the arms with the armrest. By lifting the arms maximally 20° the support must go up 15° to achieve the 1,8 cm lifting of the elbows. The aim is to position arms and shoulders at a proper height to reduce the static muscle load and to prevent an asymmetrical posture. This may be of interest for dentists with musculoskeletal complaints. *Support has to be given up to a point just before the elbow to maintain the agility of the underarm and hands. This results in it having a width of 10-12 cm and it being not too long. (Exact data are not available).*

## 11. Patient chair for a sitting dentist.

The patient chair has to fulfil the following general requirements for a comfortable position of the patient on the chair and a healthy working posture for the dentist.

- 11.1 The patient must be positioned horizontally in order for the dentist to adopt a correct sitting posture. This must be done in such a way that the patient is not put in a position below the comfort line. The comfort line is a line in the horizontal plane, extending over the patients knees, that runs in the horizontal direction of the nose of the lying patient. It is uncomfortable for the patient when the top of the nose lies below the comfort line. *Lying below the comfort line will cause damming of the blood circulation in the patient's head making him feel uncomfortable. When the patient lies horizontally the opening of the mouth of the patient becomes oriented as much as possible towards the dentist and the teeth are positioned as near as possible to the upper body of the dentist. The dentist is then able to move freely in all working positions, with his legs below the back of the patient chair. This also enables the dentist to move easily from one sitting position to another.*  
*Thus a horizontal position of the patient is necessary so that the dentist can remain sitting upright and to allow him to move and change position as much as possible, around the head of the patient, during patient treatment. The treatment can then be carried out without bending forward or sideward and rotating the vertebral column. This also makes it possible for the dental assistant to sit with her legs below the back of the chair opposite the dentist.*
- 11.2 The patient must lie comfortably without feeling pressure from the form of the back or the seat of the patient chair. Curvatures and a lordosis support are often uncomfortable because they frequently, and mostly unintentionally, interfere with the anatomical characteristics of the patient.
- 11.3 Just before the rear of the seat a sunken sitting area, with only a small deepening of the seat by 3 cm for the buttocks of the patient, has to be present. *This enables the patient to sit down on the seat as far back as possible and prevents gliding away during seating. The deepening has not to exceed 3 cm because a further deepening of the seat causes an overstretching of the back of the patient. This is uncomfortable for the patient, especially for older patients and the many patients with back problems. This unhealthy situation has to be avoided.*
- 11.4 This is also the reason why a smooth transition between the upholstery of the back and the surface of the seat is necessary *because when sitting upright the tuberosities ischii, at the underside of the pelvis, which bear the weight of the upper body during sitting, are placed, on average, 13 cm before the back of the seat (SRP)\* but as soon as the body is positioned horizontally the back turns backwards around the connection line below the tuberosities ischii (this is called "rocking" around the tuberosities). In this way about 13 cm of the pelvis, i.e. the lowest part of the back, will be positioned on the seat. So for a comfortable positioning of the back of the patient the surface of seat and back of the patient chair must form a continuous surface.*  
*\* The Seat Reference Point, SRP, is the crossing of the tangent lines of seat and vertically placed back of the patient chair.*
- 11.5 The chair needs to have a flat surface in order to achieve a relaxed horizontal position of the patient. Additionally there should be no distinct angle between the seat and leg support. If present this should be restricted to a smooth transition of not more than 15° A greater angle will result in interference, mostly occurring with respect to the dimensions of patient's legs. More importantly, a pronounced angle will result in the knees/legs of the patient being positioned too high. This will result in a positioning of

the back of the chair with the upper body in an oblique position to avoid a position with the head below the comfort line, instead of horizontally. *This will happen when the nose of the patient comes to lie below the horizontal plane extending over the patient's knees. The more difficult it is to place the patient completely flat - that is with his whole body and head in a horizontal position - the more difficult it will be for the dentist to sit in an upright posture.*

- 11.6 If a small rise between seat and leg support is desired e.g. for older patients, then a small pillow could be positioned below the knees. This should produce no more than an angle of 15°, *the maximum needed for this purpose.*
- 11.7 The lower legs of the patient have to be positioned in line with the body to prevent them hanging down and interfering with the blood circulation. It is particularly important that patients with thrombosis do not lie with their legs hanging down.
- 11.8 The patient should lie with the shoulders completely supported, in order to avoid strain in the muscles of his shoulders, neck and mouth, which in turn hampers a relaxed position of the patient and opening of the mouth.
- 11.9 The neck of the patient must be supported under the cervical vertebrae C4-C7, i.e. the lower part of his neck will be in contact with the support of the shoulders, while the upper part of the neck, especially C1-C3, has to be left free for movements of the head (*precisely the reverse of what generally happens now, leading to an uncomfortable situation for the patient*). The height of the support has to match the individual height of the neck curvature, varying normally from about 4 until 8 cm, while for kyphotic patients up to 15 cm may be needed (*no exact data are available*).
- 11.10 The patient must be able to lie in a straight line on the seat and back of the chair in the 11.00, 12.00 and 13.00 o'clock positions to fit the positions of the right handed and left handed dentists and turning the head of the patient around 3 axes for fulfilling the conditions for sitting symmetrically upright.  
*Rationale: It appears that, in reality, dentists do not work in the 12.00 o'clock position for more than about 10 % of the time. They work mainly around the 11.00 o'clock position (left handed dentist 13.00 o'clock position). The 11.00 o'clock position can be regarded as the starting position, around which treatments of the mouth are carried out, for the following reasons:*
- \* this position fits the sitting position of the dental assistant opposite the dentist better;*
  - \* this position provides a better relation with the instruments, than the 12.00 o'clock position when further reaching for these is often required and furthermore this occurs over the face of the patient;*
  - \* this position provides a better point around which the working stool can be moved. The dentist can move, with the working stool, to the right for treatments at the right side of the mouth; and to the left for treatments at the left side of the mouth. This movement can be used instead of bending sideward and so it enables the dentist to remain sitting upright. This is important because:*
    - \* a lot of preparations, such as crown and bridge preparations, require a change of instrument position and thus a change of sitting position to maintain sitting upright;*
    - \* many activities such as examinations of the mouth and scaling require access to all sextants of the mouth, therefore the whole range of sitting positions between 9.00-12.00 o'clock are needed and sometimes even positions outside these.*

*In all sitting positions around the head of the patient the working field in the mouth must be placed straight before the dentist directed to his viewing direction. The headrest must make possible the required 3 turnings of the head of the patient. This may occur by a pillow with appropriate form and dimensions or a shell shaped headrest with 3 axes.*

According to legal rules the dental assistant must be able to work sitting with a healthy posture as described. With a dentist sitting in a 12.00 o'clock position this is practically impossible.

11.11 The 3 movements of the head of the patient are:

\* forward with the occlusal plane of the lower jaw from about 0° (horizontally), when the dentist is sitting next to the patient, up to about 45°, when the dentist is sitting behind the head of the patient; and backward with the occlusal plane of the upper jaw 20-25° behind a vertical plane for treating the upper jaw;

\* lateroflexion that means turning the head obliquely sideward, about 30°, to the right or the left. This movement is always followed by a movement of the upper body of the patient, in the same direction, to get the head and body in a straight line. It is not comfortable for the patient to turn his head obliquely sideward, in lateroflexion, using a broader angle or during longer periods, and especially for older patients. Therefore it is necessary for the body of the patient to follow the position of the head when positioned obliquely on the headrest so that the body lies more or less in a straight line;

\* around the length axis of the head, maximally about 45°, to the right or the left.

*Explanation. The surfaces of the teeth and therefore the working fields in the mouth are oriented in three directions. In order to turn the various working fields of the teeth so that they become orientated towards the viewing direction of the eyes of the dentist, it is essential that movement can occur in all three different directions. Therefore during examinations, preparations, scaling etc, a three dimensional rotation of the patient's head must be possible, in order that the best possible position for observation can be obtained. Otherwise, due to the effect on the kinematic chain, the rotations of the eyeballs lead to an unfavourable mostly asymmetrical posture. The symmetrical upright posture must be achieved by looking for the optimal combination of turnings of the head of the patient and the sitting position of the dentist by moving around the headrest. It is impossible to do this by positioning the patient chair obliquely because one eliminates then one of the turnings of the head necessary to obtain the proper direction of the working field toward the viewing direction. While the dentist has to turn away from the patient in order to operate the controls which effect the movement of the patient chair. Finally the possibilities for an optimal sitting position in relation to the instruments and dental assistant are reduced.*

11.12 The upholstery must be firm but not hard and allow a certain adaptation to the anatomical shape of the patient (*further data are necessary*).

11.13 Armrests have to be minimal in connection with the possible hindrance of the dentist, when standing to carry out some procedures.

11.14 A distinct or fixed lordosis support in the back of the patient chair is unwanted because this generally interferes with the individual anatomical dimensions but a lordosis support that can be adjusted individually could be a solution.

11.15 The upper body of the patient rotates around an axis below the tuberosities ischii when the patient is positioned in a horizontal or vertical position in the patient chair. This is an important aspect which needs to be considered when designing the mechanism for turning and moving the back of the patient chair.

Summary. The patient chair needs to provide the patient with a comfortable horizontal position during treatment, making it possible to lie straight or obliquely in different directions. For this purpose a flat chair in both directions is required with only a small deepening of the seat for the backside of the patient, while the legs of the patient are not pushed upwards; or only to a very limited extent. Otherwise the patient can not be positioned sufficiently horizontally with his upper body because he will pass the comfort line sooner (horizontal line over nose and knees) which results in damming of the circulation in the head. Construction of the back of the chair must make it possible to adapt the length of the back of the patient chair to the length of the back of the patient, as far as this is positioned on the back of the patient chair (*minus 13 cm on the seat*). The headrest with neck support is connected directly to the back. Finally the dimensions and the form of the headrest with neck support have to fit the movements of the head of the patient without hampering the dentist when approaching the head/mouth of the patient.

## 12. Dimensions of the patient chair for a sitting dentist.

12.1 Minimal height of the working field for the P<sub>(F)</sub>5 dentist is: 77.6 = 78 cm (*minimal sitting height 46.9 cm, height elbow 20.5 cm and lower arms lifted 15° = 10.2 cm. The upper arm is positioned 15° forward, see for explanation 14.1 and 14.3*).

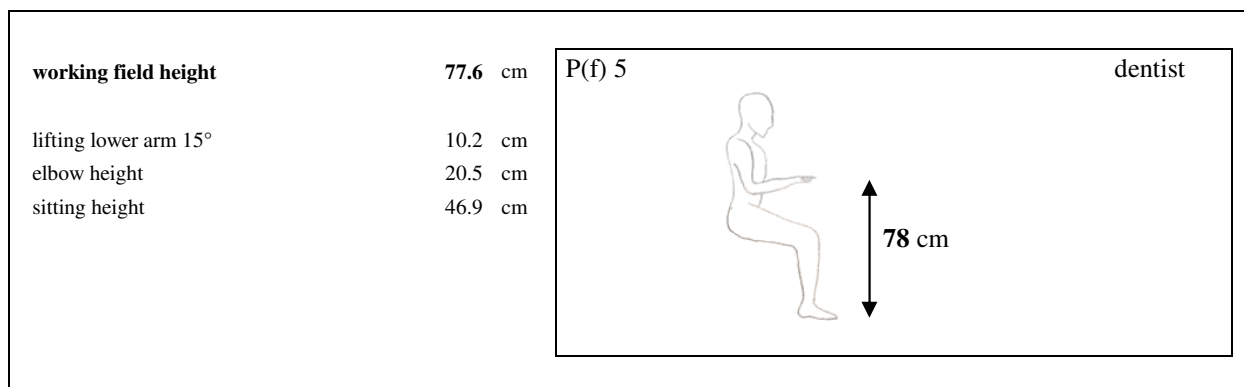

fig. 12.1

12.2 Maximal height of the working height for the P<sub>(M)</sub>95 dentist is: 106.7 = 107 cm (*maximal sitting height 62.8, height elbow 29.9 and lower arms lifted 15° = 14 cm*).

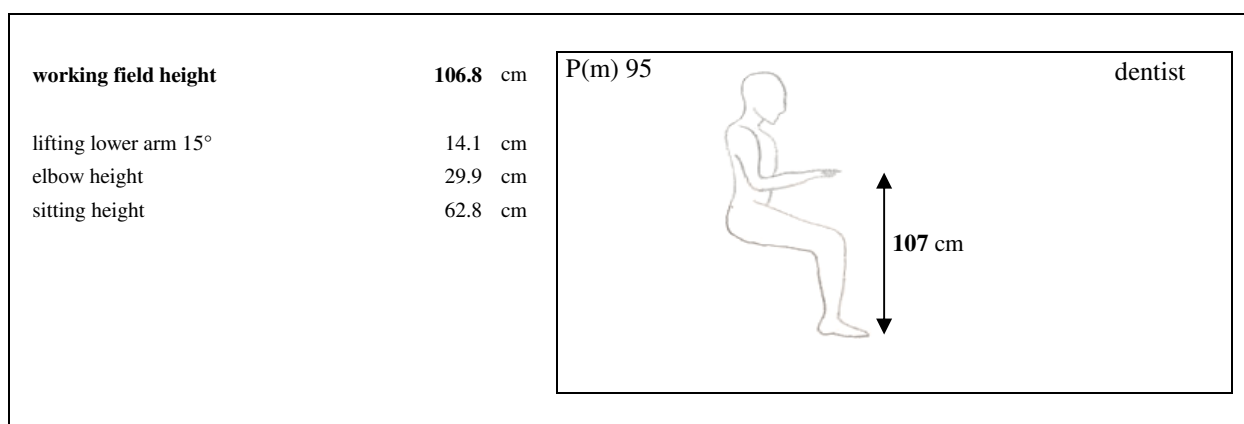

fig. 12.2

12.3 Deepening of the sunken sitting area for the buttocks of the patient is approximately 3 cm (*has been established empirically*), about 13 cm from the rear of the seat, which is on average the place where the tuberosities ischii are positioned. The width of this deepening in the middle part of the seat corresponds with the width between the external limits of both of the tuberosities, at the underside of the pelvis, this being about 15 cm. From the deepening a softer upholstery rises steadily backward, sideward and in the direction of the back of the knees.

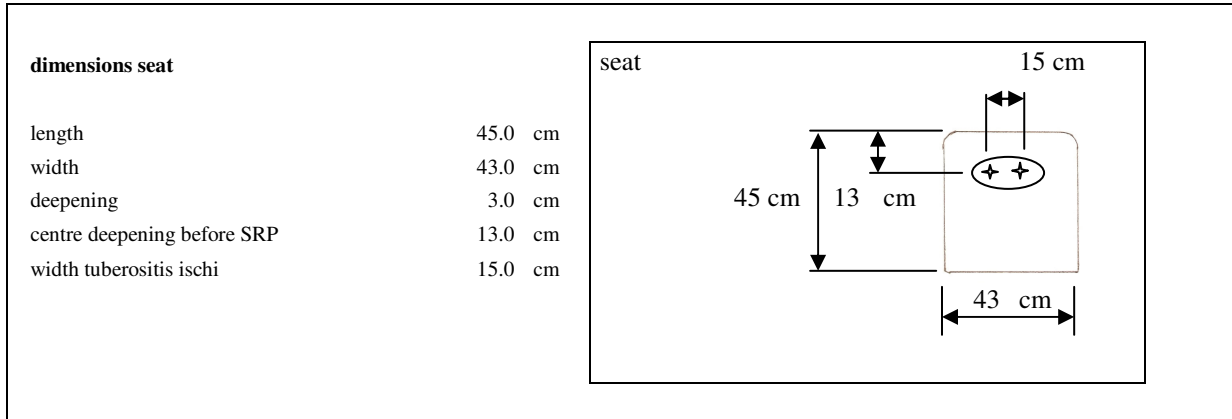

fig. 12.3

12.4 The height of the seat of the patient chair for the backside of a horizontally positioned patient for the P<sub>(F)</sub>5 sitting dentist is: 53 cm (*underside of the body positioned circa 25 cm below the level of the incisors on 78 cm, on the place where the seat is deepened 3 cm, taking into account the impression of the upholstery by small patients. The distance of 25 cm vertically between level of incisors and underside of the body is on average a good estimate of this distance*). The molars are located about 4 cm lower than the incisors but for positioning these at working height the patient chair can be placed about 4 cm higher).

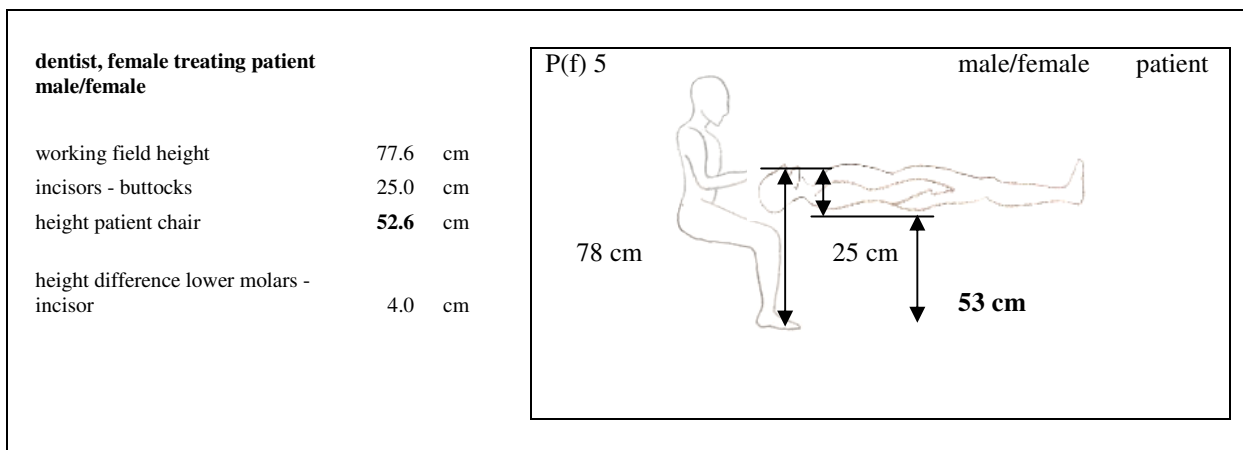
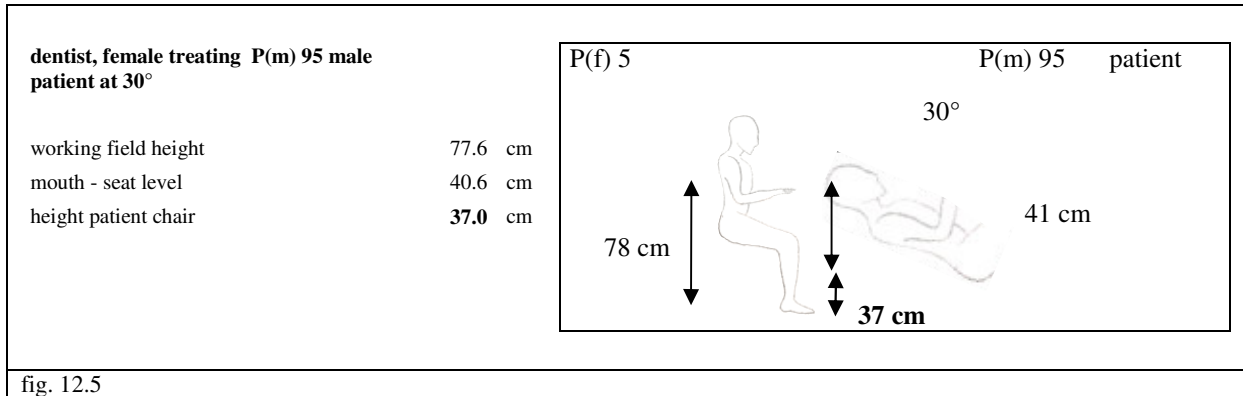

fig. 12.4



12.5 The height of the seat for the backside of a P<sub>(M)</sub>95 patient for the P<sub>(F)</sub>5 dentist when the back of the patient chair is positioned 30° obliquely (in relation with a horizontal plane) is 37 cm. An oblique position of the patient of 30° is used e.g. for treatment of the lower jaw from the 9.00-10.00 o'clock position and also for special groups of patients like pregnant woman at the end of the pregnancy and different medical indications such as some heart and respiratory problems. These patients are then also lying more obliquely in their bed. In most cases the patients can be treated with the back of the chair in a 30° position (in relation with a horizontal plane).



12.6 The height of the seat for the backside of a horizontally positioned patient for the P<sub>(M)</sub>95 dentist is: 86 cm. (For the P<sub>(M)</sub>95 dentist placing the molars at the right working height means that the incisors are positioned about 4 cm higher than the molars. So, for determining the maximum seat height for the P<sub>(M)</sub>95 dentist the height of the incisors is taken, 107 cm, plus 4 cm raising for positioning the molars on the maximum working height, minus 25 cm for the body of the patient).

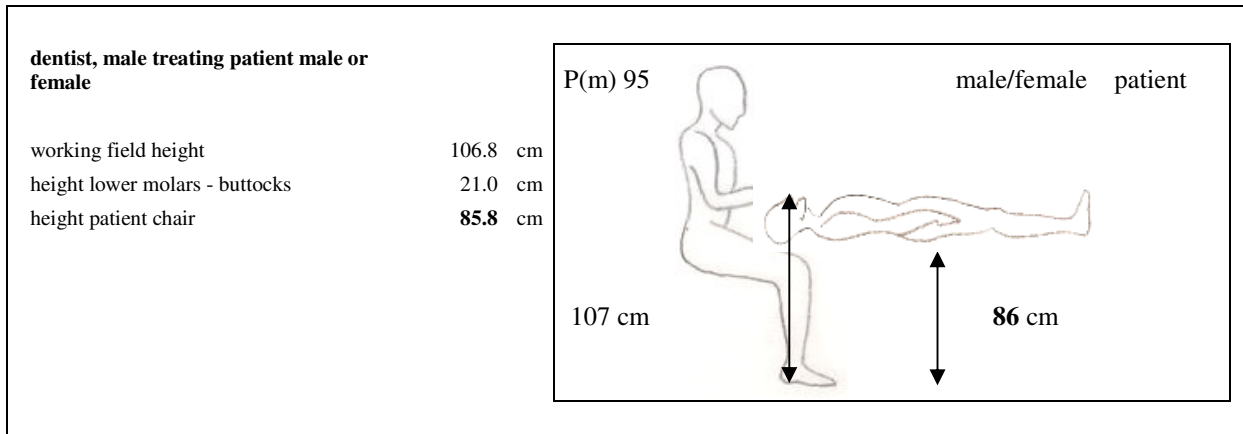

12.7 The resulting range for adjusting the height of the seat for the sitting dentist goes from a minimum of 37 cm to a maximum of 86 cm. But we recommend a minimum height on 35 cm in order to take into account the requirements for a standing P<sub>(F)</sub>5 dentist (see 16.9) and the maximum height of 90 cm (4 cm's extra above 86 cm for taller dentists). Additionally it appears from further technical information that lower than 35 cm and higher than 90cm causes technical drawbacks.

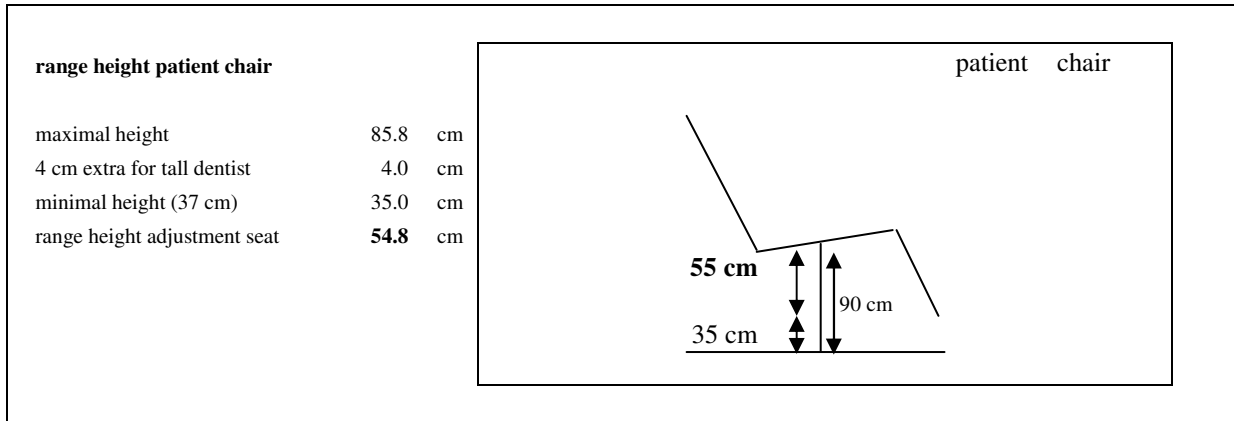

fig. 12.7

12.8 The minimal length of the back for supporting the shoulders of the P<sub>(F)</sub>5 patient on the sides of the top of the back, without hampering the dentist is:  $40.9 = 41$  cm (*shoulder length 53.9 minus about 13 cm of the back lying on the seat*). And in the middle of the top of the back where the shoulders are about 3 cm higher is: 44 cm, in order to support the shoulders completely, together with the connecting head support. It is crucial that this support for the shoulders and the lower part of the neck is joined together, in order to obtain a relaxed patient and an optimal opening of the mouth.

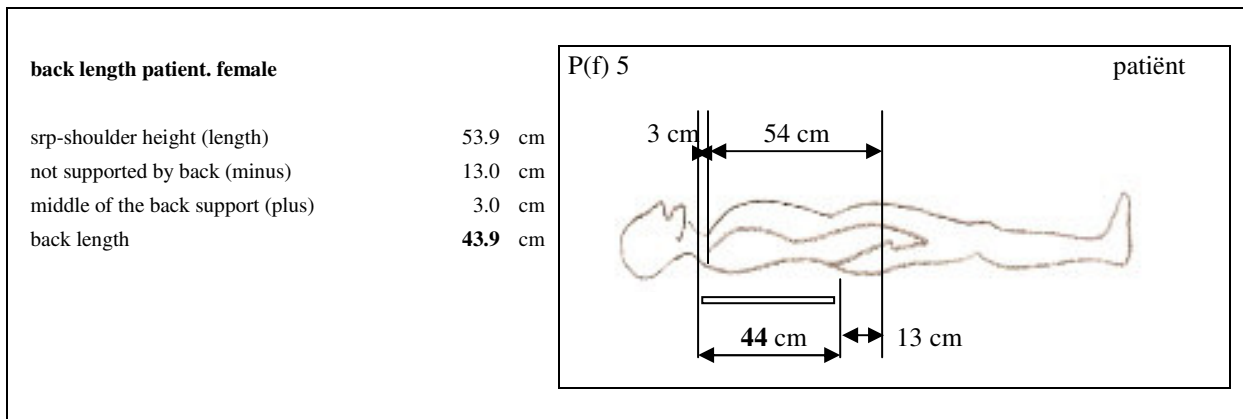

fig. 12.8

12.9 Children shorter than the P<sub>(F)</sub>5 patient can be pulled upwards until the head can be placed in the desired position.

12.10 The maximal length of the back for the P<sub>(M)</sub>95 patient is: 55.6 = 56 cm on the sides of the top (*shoulder length 68.6 minus about 13 cm of the back lying on the seat*) and in the middle of the top of the back is plus 3 cm: 58.6 = 59 cm.

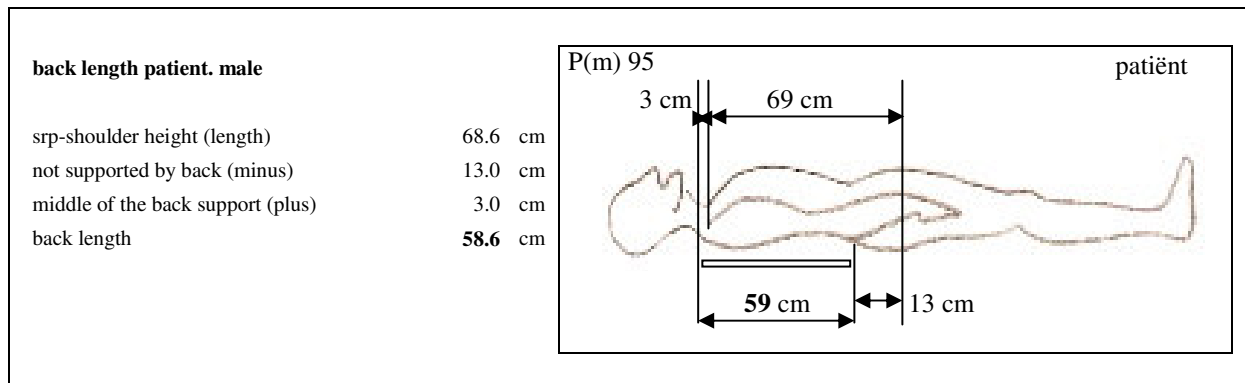

fig. 12.10

12.11 The resulting range for adjusting the length of the back is 14.7 = 15 cm, this should be attained by moving the back forward and backward or by shortening and lengthening the back, preferably with the mouth kept in the same place in relation to the position of the dentist.

12.12 The width at the top of the side of the back for supporting the shoulders without hampering the dentist is: 42 cm. *At this point two criteria have to be fulfilled: maximum support of the shoulders of the patient and no hampering of the dentist when approaching the patient. (Shoulder width of P<sub>(F)</sub>5 patient is 38.1 cm and of P<sub>(M)</sub>95 patient 51.7 cm. The shoulder blades of the P<sub>(M)</sub>95 can, according to an estimate, be supported together with a small part of his arms, by taking 42 cm as the width at the top of the side of the back, whilst allowing the patient to move a little to the right or left for the lateroflexion of the head, see 11.10). The change from top to side has to be rounded off well to avoid hindrance for the dentist.*

12.13 The width in the part of the back where the elbows need support is 48 cm (*Taking into account the width of upper body and elbows of the P<sub>(M)</sub>95 patient a width of 56 cm would be necessary. The side of the back has to be made such that the elbows can not glide away to find a support. Therefore more than 56 cm would be desired for tall patients but they could cross their arms over their body. However, the width of the back of the patient chair has to be as small as possible for the standing dentist. A P<sub>(F)</sub>5 dentist must be able to have the working field within a distance of about 27 cm from the upper body. (See 14.1), without losing contact between her upper arms and upper body; by making movements her reach is a little farther. This holds true when all conditions are favourable e.g. the dimensions of the dentist. Otherwise one or more cm's have to be subtracted from 27 cm. The width of the hips of a P<sub>(M)</sub>95 patient is 42.9 and of a P<sub>(F)</sub>95 patient 47.7 (This is an unusual situation wherein a dimension of the P<sub>(F)</sub>95 is more extensive than of the P<sub>(M)</sub>95). Therefore it seems rational to take 48 cm as the width of the back of the patient chair, where the elbows have to rest, though tall patients may be broader. The elbows of the patient can be supported on foldaway elbow rests at the sides of the back, as a continuation of the back. Both supports can be 11 cm broad so that the elbows can be supported comfortably at some distance from the upper body without gliding away. For the elbows of the P<sub>(F)</sub>5 patient the support must be available 34 cm below the top of the back and for the P<sub>(M)</sub>95 patient 49 cm below the*

top. The support must therefore be more than 15 cm long in order to enclose the elbows. The best solution for the placement of this support needs to be worked out further, but it could be done by fixing it at the side of the seat. The underside of the back can narrow to 43 cm, the width of the seat (see 12.15).

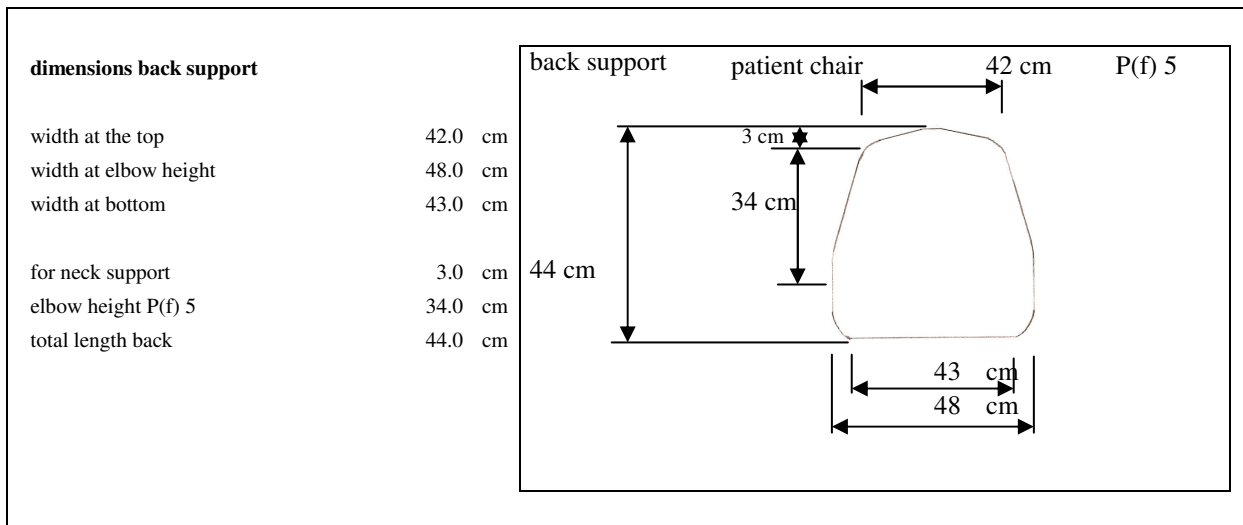

fig. 12.13 a

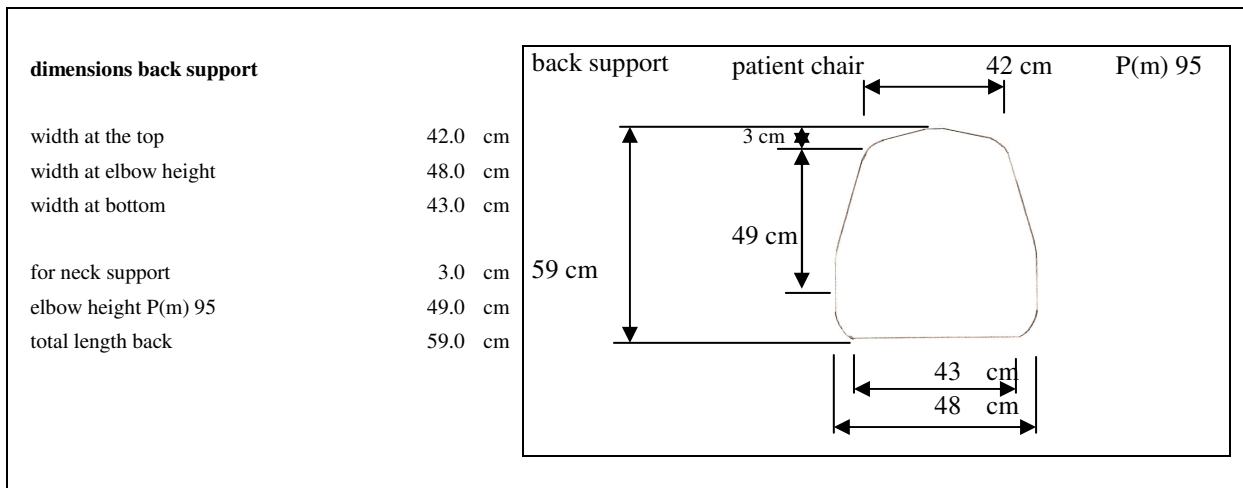

fig. 12.13 b

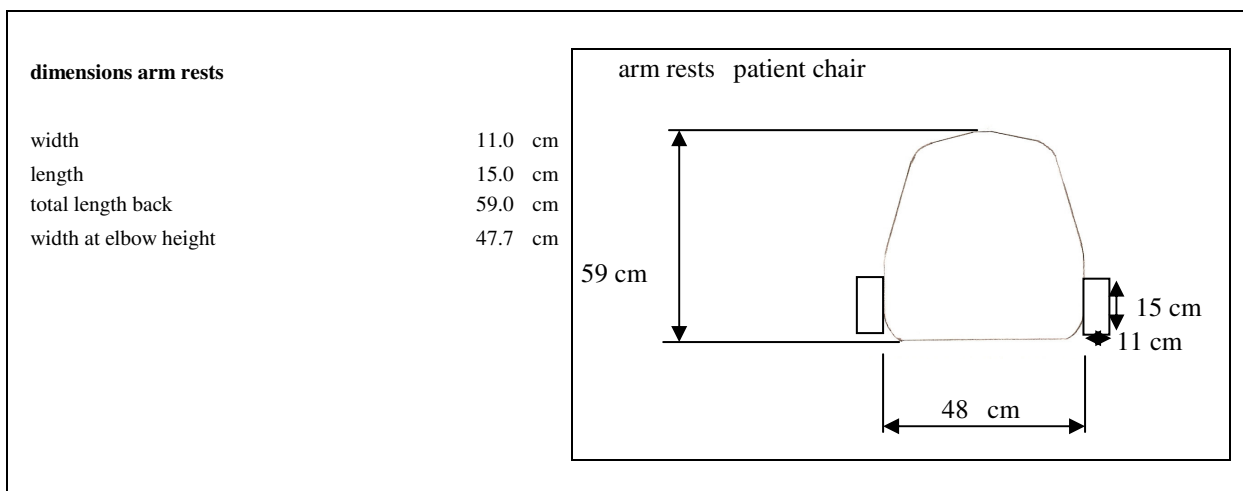

fig 12.13 c

12.14 The total thickness of the back has to be very small: 4 cm; and in the middle part of the back not more than 6 cm over a distance of about 50 cm in order to allow the dentist and dental assistant to sit with the legs underneath the headrest and chair. *The thighs can, sitting with an angle of 110°, extend forward more than 45 cm. For this purpose and for a dentist sitting in the 8.30 o'clock position and the dental assistant sitting just opposite a dentist in the 11.00 o'clock position, i.e. in the 15.30 o'clock position, it is necessary for the back of the patient chair to be as thin as possible, certainly for the first 45-50 cm from the top of the headrest. This is especially important for small dentists so that they are able to position the head of the patient and headrest plus the back of the patient chair between the thighs and lower arms. This is also necessary in order to allow space for the sitting position of the dentist and dental assistant at the sides of the patient chair.*

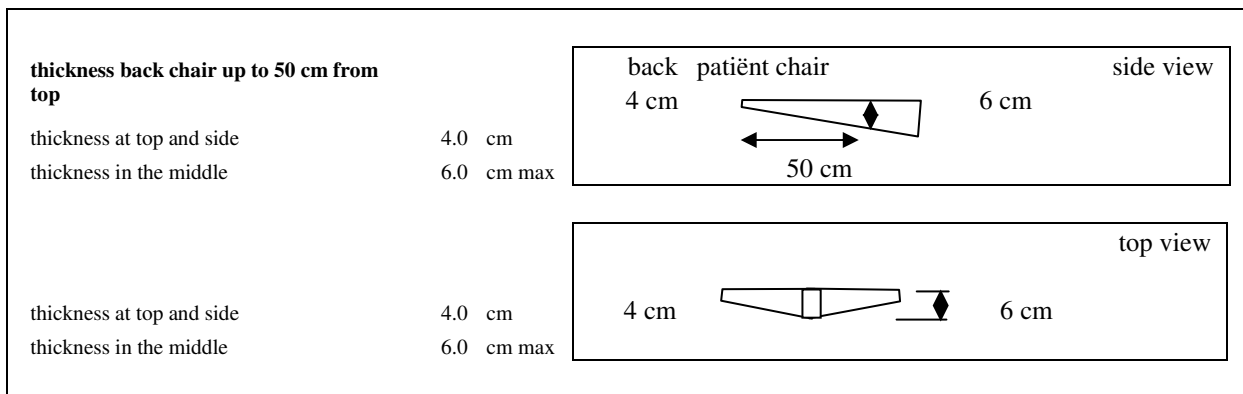

fig.12.14

12.15 The width of the seat is 43 cm, but where the leg support starts, this width widens so that at the end of the support for the legs it becomes 55 cm. This then allows the positioning of the lower legs of patients in a oblique position, and therefore allows a diagonal position of the patient on the chair. This is particularly important, as it then allows the patient's body to remain aligned with the head during positioning of the head in lateroflexion. *(For further information regarding the length of the seat and support of the legs, see 16.5).*

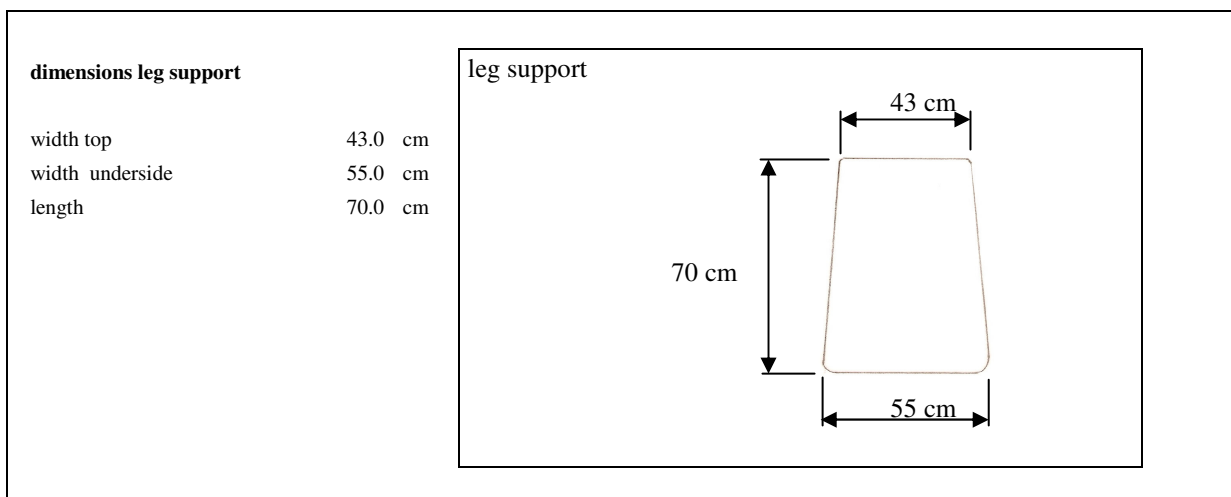

fig. 12.15

12.16 For seating the patient the angle of the back is 70 – 80 ° backward ( *in relation to a horizontal plane*) and the angle of the seat should be approximately 10 ° backward.

12.17 The height of the seat for seating a patient is not a fixed height. This varies in accordance with the wishes of the dentist and is around 50 cm *as far as we could check this*.

12.18 The movement, from being seated upright to achieving a horizontal position of the patient has to take between 10 and 20 seconds (*according to available information*). It must also be possible for this occur in two phases, in order to maintain the comfort of the patient. *Problems may arise with patients with a low blood pressure. Then a lower speed or a variable speed is necessary.*

### 13. Support of head and neck by headrest and neck support.

13.1 The width of the headrest for the lateral flexion of approximately of 30° (sideward movement of the head) is 24 cm at the place where the neck is positioned, on the neck support, on the headrest. *The neck is moving approximately 4 cm towards the side and away from the middle of the head rest, the width of the neck support is 16 cm so half of 16 = 8 cm of the neck support moves 4 cm sideward to either the right or the left so that 12 cm is needed at both sides. The mouth moves approximately 5 cm sideward during the lateroflexion and the head, near the back of the head, about 6cm. The contact surface of the back of the head with the headrest is about 8 cm broad, 4 cm at both sides of the middle of the headrest. This means that, to maintain contact with the back of the head, 6 + 4 = 10 cm, at bothsides of the middle of the headrest is needed; in together 20 cm. This width of headrest is required up to a distance of at least 17 cm, measured from the top of the shoulders at the sides. (*The distance from the top of the shoulders to the back of the head is on average about 17 cm*). Above this contact area (*with the back of the head*) the width of the headrest can decline and follow the rounding of the head of the patient within the contour of the head; taking into account the width of a head of a P<sub>(M)</sub>95 patient is 16.3 cm. The dimensions of the headrest together with the range of the head movement fall within the reach of the P<sub>(F)</sub>5 dentist (*When a right handed dentist uses a lateroflexion to the left the distance of the working field to the right side of the headrest becomes maximal i.e.19 cm = half the width of the headrest, 12cm, plus 5cm due to the sideways movement of the mouth to the left, plus 2 cm from the middle of the mouth to the left jaw*)*

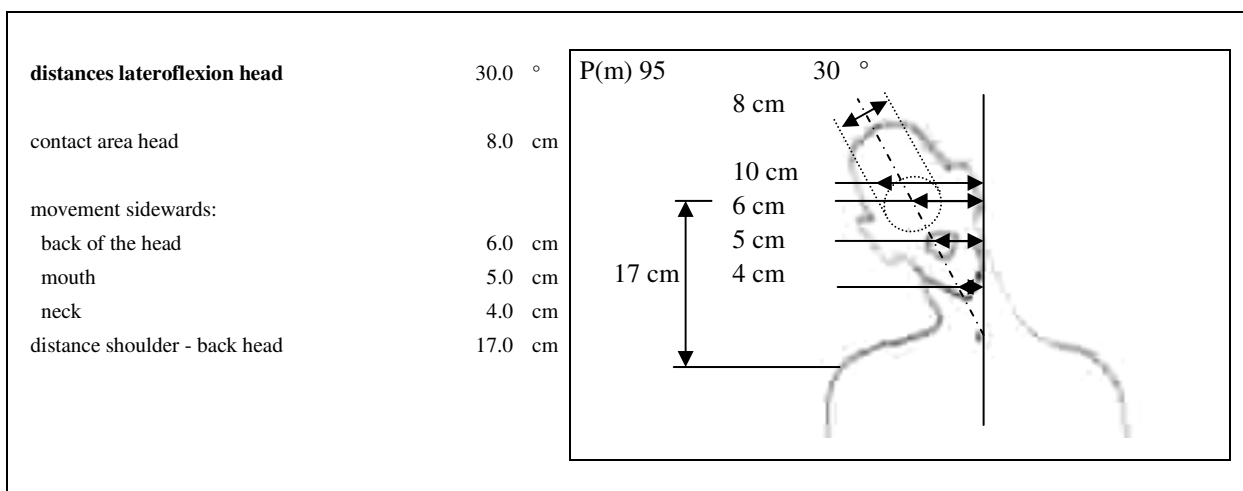

fig. 13.1

13.2 The form of the headrest is rounded off to avoid hampering the dentist when approaching the head of the patient.

13.3 The length of the headrest above the shoulder line in the middle is: 25 cm. (*length head P<sub>(M)</sub>95 patient is 29.7 cm above the middle part of the shoulders*). The top of the rear of the head of the patient, 4 cm, can be left unsupported because the point of support of the head is lower. In this way the form and thickness of the headrest will be further removed from the body of the dentist while the head can be turned slightly more backward. Because of this the length of the headrest directly joined with the middle part of the back has to be 24.7 = 25 cm. The length of the head of the P<sub>(F)</sub>5 patient is 25.8 cm therefore approximately the whole length of the headrest will be used for small patients.

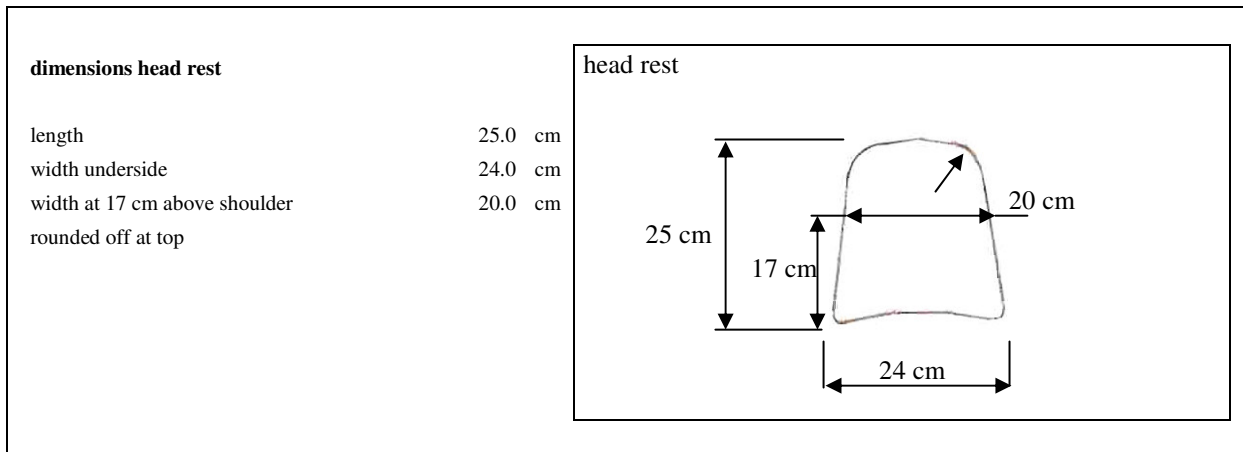

fig. 13.3

13.4 The thickness of the headrest should be about 3 cm towards the top dropping to 0.5 cm to attain as much space as possible around the head of the patient for an easy vertical reach to the patient's mouth. The head, and thus the working field in the mouth, becomes positioned 1.8 cm lower, by placing the top of this headrest 4 cm from/below the crown of the head (see 13.3).

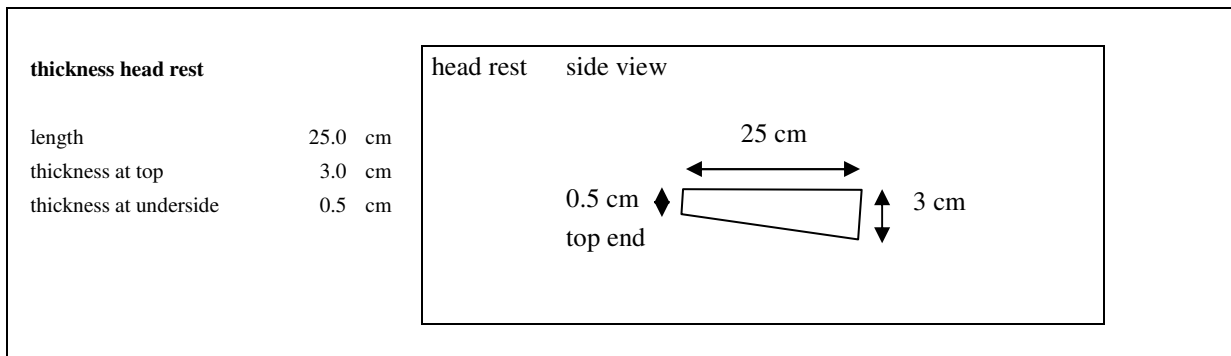

fig. 13.4

13.5 The neck support underneath the cervical vertebrae C4-C7 should consist of a small bent ring-shaped support, with a width of 16 cm (*see 13.1*) and a basis of about 5-6 cm, (*which can be moved sideward together with the head of the patient*). This should also be provided with the means to adapt the height of the neck support to the dimension of the neck curvature, ranging from about 4- 8 cm in normal situations. A headrest with 3 axes could possibly be used.

13.6 The headrest should be able to be turned backward 20° so that it can be used when treating patients on medical grounds with the back in a 30° position. For patients with kyphosis, it must be possible to bring the neck support about 15° forward (*No exact*

*data regarding the required adjustments of the headrest backwards and forwards are available).* By adjusting the length of the back of the patient chair in accordance with the length of the back of the patient the rotation axis of the headrest is placed approximately at the same height as the rotation axis of the head for turning forwards and backwards.



#### 14. Relation working field in mouth patient and upper body dentist.

An essential aspect of the balance of the kinematic chain is the position of the working field vertically and horizontally before the upper body. This position has to correctly relate to the viewing direction of a slightly bent head. When the dentist has arms with longer dimensions, this can be arranged more easily, but for very small dentists it is difficult to establish this relation well. In this case the upper arms have to be positioned 15° forward, which is the maximum forward position, otherwise a distinct protraction of the shoulders occurs, and this has to be avoided. The lower arm will be lifted 15° which results in raising the hand 10.2 cm (see 12.1). When all the conditions are favourable, the limits of the kinematic chain for reaching the maximal distance of the working field from the body of the dentist are as follows.

14.1 The horizontal distance is 27 cm for a P<sub>(F)</sub>5 dentist. (The length of the lower arm of a P<sub>(F)</sub>5 dentist is 40.7 cm. When the upper arm is hanging down vertically, approximately 10 cm of the lower arm - when placed horizontally - is positioned beside the upper body and approximately 30 cm before the upper body, with the fingers stretched. Because manipulation is carried out with instruments, the working field lies approximately 5 cm behind the top of the stretched fingers and by moving the fingers with the instruments towards the symmetrical plane the distance from the upper body is reduced by a further 5 cm, so that 20.7 cm remains before the body. By placing the upper arms in an angle of 15° and lifting the lower arm 15° the fingers with the instruments become placed 6.3 cm forward so that the maximal reach is 27 cm. Provided that is, that the conditions are favourable like the size of the operator, the volume and position of the breasts and the condition of the patient. This will often result in an available distance shorter than 27 cm).

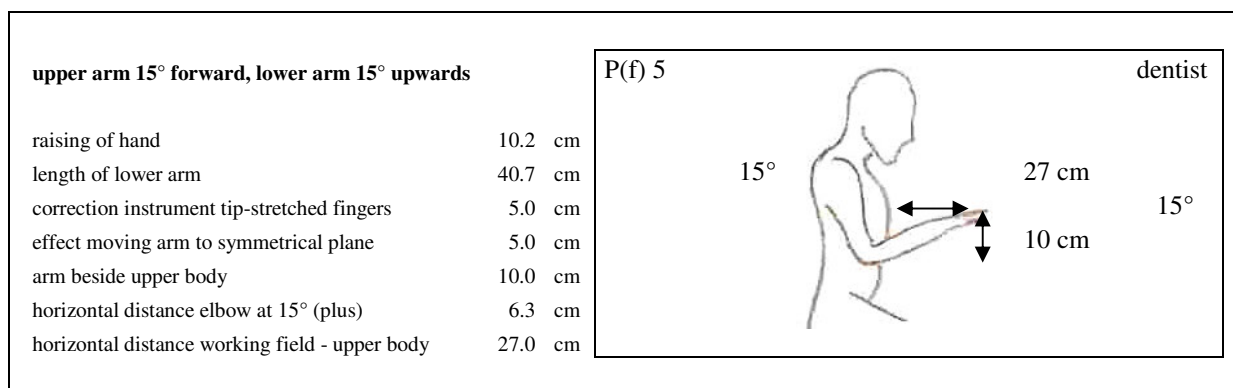

fig. 14.1

14.2 The distance from the crown of the head of the patient to the upper incisors is about 18 cm for the P<sub>(F)</sub>1 patient ranging up to about 19 cm for the P<sub>(M)</sub>99 patient and the distance to the lower incisors is 4 cm further = maximally 24 cm. (The distance of the crown of the head to the upper incisors ranges from 15,2 cm for the P<sub>(F)</sub>1 patient up to 16.9 cm for the P<sub>(M)</sub>99 patient plus 2 cm for the hair and not too close contact (but this may vary) leading to a distance of the working field before the body of 17.2 cm up to 18.9 = 19 cm. The distance to the lower incisors is 4 cm more resulting in a distance of the working field 23 before the upper body). When conditions are not favourable not enough space is available in the horizontal plane.

14.3 The vertical height of the working field above the horizontal plane that starts just above the upper leg before the stomach (where generally the headrest is placed) is 27.5 = 28

cm when the headrest used is that described in 13.4. And this could be reduced to 25.7 when the headrest is positioned 4 cm before the stomach (2 cm free space to be able to move freely with the upper legs below the back and headrest, on average 2.5 cm for the headrest and 23 cm vertical height upper incisors of a P<sub>(M)</sub>99 patient = 27.5 cm; or 25.7 cm when the headrest is placed 4 cm before the stomach. For the P<sub>(F)</sub>1 patient the vertical height of the upper incisors is 18 cm resulting in a total height of 22.5 or 20.7 cm, when the top of the headrest is placed 4 cm before the stomach).

By positioning the upper arm 15° forward and lifting the lower arms 15°, a space of 10.2 cm is secured vertically. The further necessary height has to be obtained from the distance existing between the upper leg, just before the stomach up to the elbow. It appears that this distance shows a great variation ranging from about 7-8 cm or higher, as a consequence of the differences of length of the upper arms and the diameter of the upper legs.

It could be possible to position the lower arm in an angle of 20° so that 3 cm more becomes available, but then the horizontal distance of the hands to the upper body decreases. Another possibility is to place the back under a small oblique angle. This results in a lowering of the working field. But then the head of the patient has to be turned further backwards.

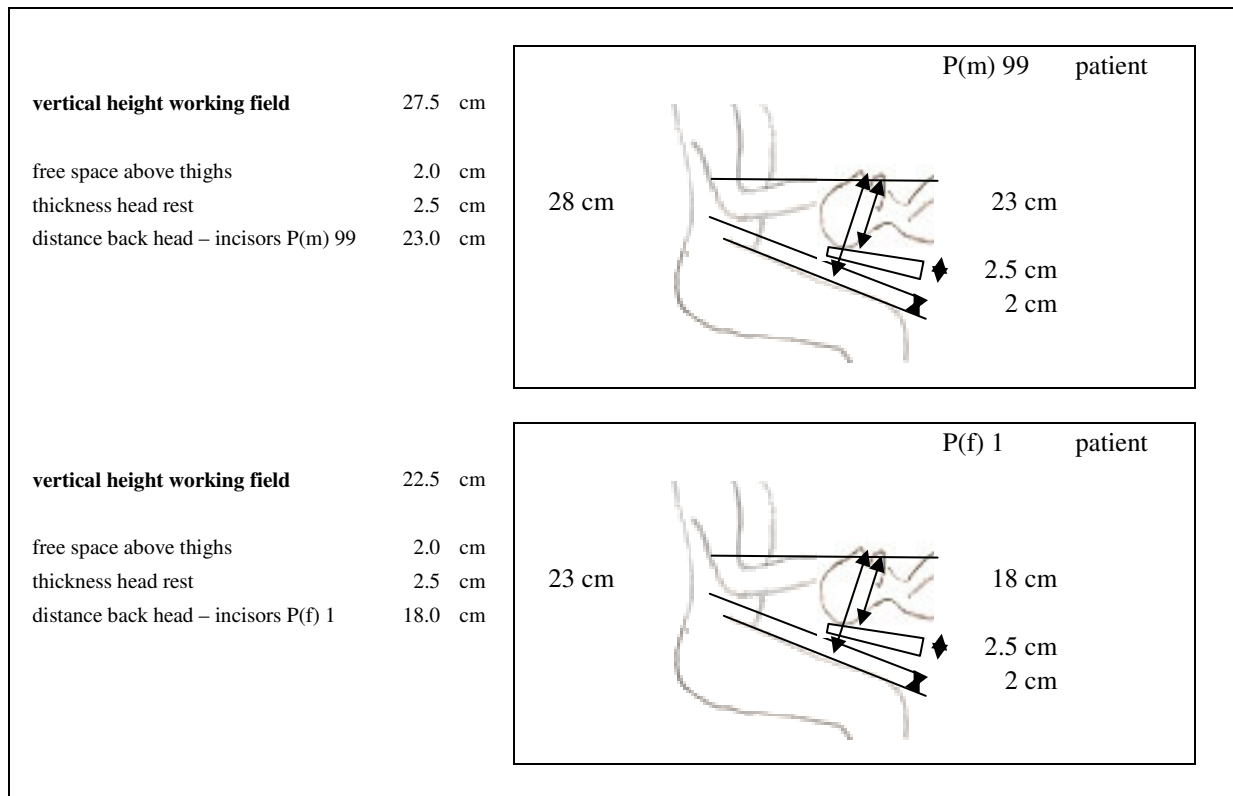

fig. 14.3

**Conclusion.** Problems exist for very small dentists with respect to the positioning of the working field in the mouth in an acceptable relation with their body in order to obtain a healthy posture. Moreover only a restricted area vertically and horizontally is available for the use of a microscope within a well positioned kinematic chain.

## 15. Basis patient chair.

15.1 A sitting P<sub>(M)</sub>95 dentist needs a free space for his feet and foot control behind the basis of the patient chair: 80.7 = 81 cm between the basis of the chair and the backside of the headrest, of a horizontally positioned back of the patient chair, for treating a P<sub>(F)</sub>5 patient (56.5 cm for legs, 29.2 cm for feet, 15 cm for the foot control – this measurement depends on the design – and 5 cm free room to manoeuvre).

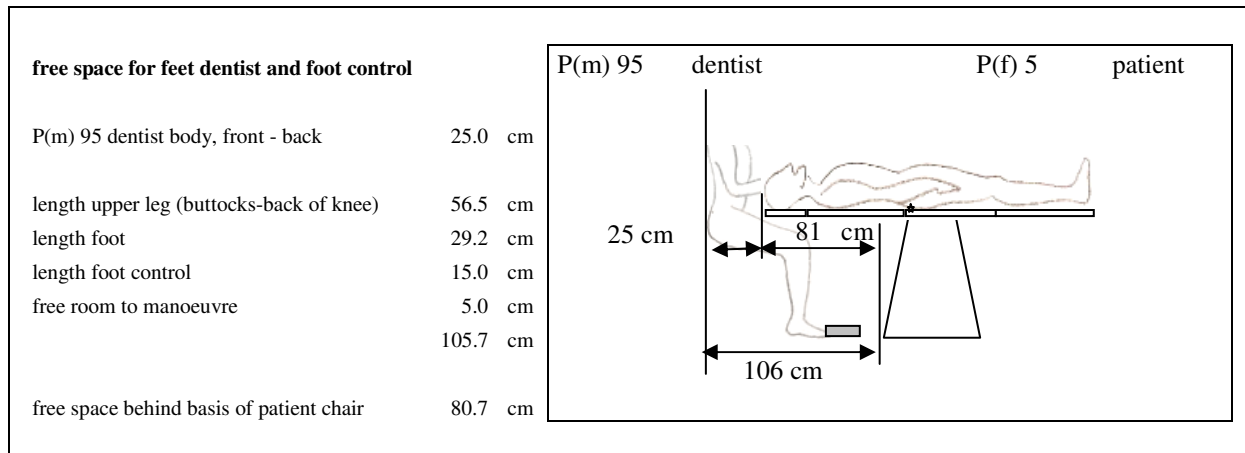

fig. 15.1

15.2 A foot control for operation of the movements of the patient chair would have to be fixed such that:

- no accidental chair movements occur;
- the dentist need not slide away from his operating posture, in a unbalanced way, to reach the chair adjustment controls with a “stretched” leg.

It is impossible to obtain an acceptable solution for a separate foot control for operations of the movements of the patient chair in connection with the free space necessary for feet and foot control. This results in the fact that operation of the patient chair must be carried out via the foot control which is used to operate the dynamic instruments or there must be an additional hand operated control.

## 16. Patient chair for working standing.

16.1 The working height for the standing  $P_{(F)5}$  dentist is: 111 cm (*height shoe 2 cm, height elbow 99.2 cm and lower arm lifted  $15^\circ = 10.2$  cm*).

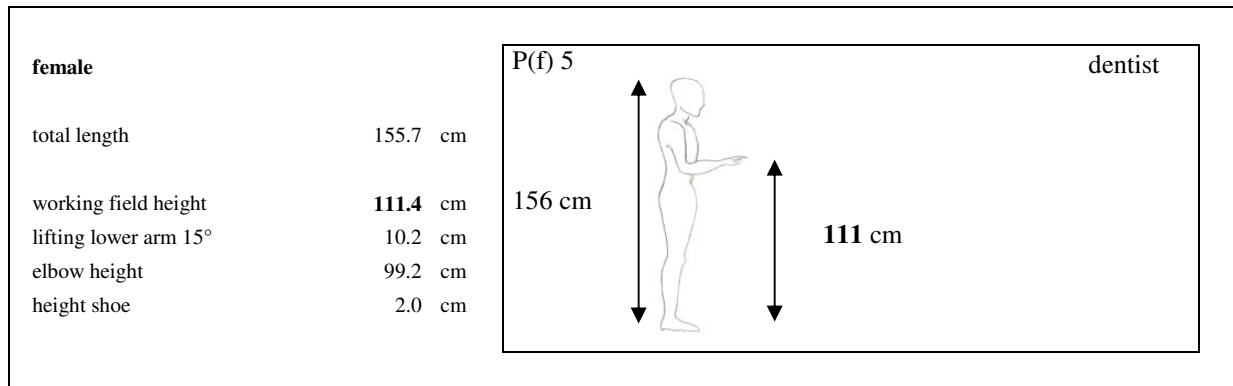

fig.16.1

16.2 The working height for the standing  $P_{(M)95}$  dentist is: 144 cm (*height shoe 3.5 cm, height elbow 126.2 cm and lower arm lifted  $15^\circ = 14.0$  cm*).

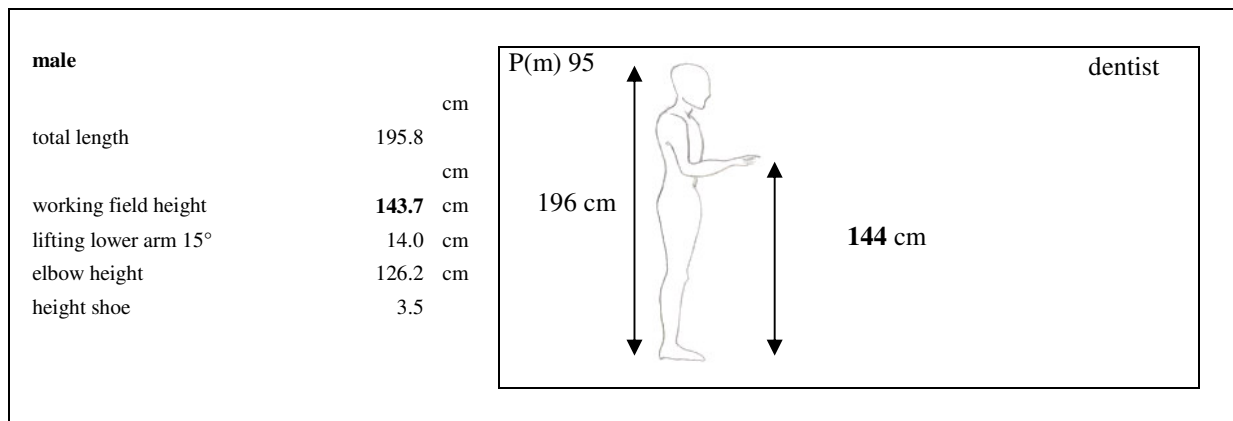

fig. 16.2

16.3 When carrying out some treatment, e.g. making a dental prosthesis, different gnathic treatment such as registration of occlusion and articulation, etc, a patient has to sit upright and it is stated that he has to sit with his legs vertically. It would, therefore, have to be possible to position the back and the leg support in a vertical position. *However we have so far found no data that states that in addition to a vertical sitting position, it is necessary for the patient to sit with the legs vertically. If this were the case then his feet would have to be supported by the floor, which is difficult to arrange for smaller patients (smaller than  $P_{(M)95}$  patients). It must also be possible to sit with the lower legs at an angle with a vertical plane at which the upper body will not be pressed against the back of the patient chair.*

Finally, it seems to be a reasonable assumption that a patient is able to sit relaxed, without the lower legs hanging down producing a strain on the back caused via the upper legs, with an angle of the leg support of  $60^\circ$  (*in relation with a vertical plane. However further investigation is required to obtain sufficient understanding of the situation*). It is important that all dentists, including small dentists, have the opportunity to position all patients vertically. However, using an angle of  $60^\circ$  for the leg support (*in relation with a vertical plane*) it would not be possible for a  $P_{(F)5}$  dentist to treat very

tall patients who were sitting in a vertical position when the dentist was standing (*see 16.10*).

For other treatments as mentioned above, like difficult extractions, giving anaesthesia, where appropriate, some treatments for anxious patients, taking pictures and X-rays, short consultations and making impressions, the patient can sit in an oblique position. To be able to sit with the lower legs in a vertical position, has never been a requirement during these treatments.

It is important to have the opportunity to alternate between sitting and standing, to be able to change postures, in order to create a dynamic method of working.

- 16.4 As determined before, patients have to be positioned horizontally with the lower legs in a straight line with the body and if necessary at an angle of maximally 15° between lower and upper legs. (see 11.5).
- 16.5 The total length of the seat and support of the legs has to be 115 cm. (A total length for the seat and support of the legs of 109.1 cm is needed for support of lower and upper legs of the P<sub>(M)</sub>95 patient: lower leg is 49.1 cm plus upper leg 56.5 cm plus shoe 3.5 cm = 109.1 cm. For accommodating taller patients 6 cm extra needs to be available, resulting in a length of 115). For the length of the seat 45 cm needs to be available because the length of the upper leg of the P<sub>(F)</sub>5 patient is 45.4, otherwise this patient cannot sit comfortably; for the P<sub>(M)</sub>95 this length is 56.5 cm. The resulting length of the support for the legs is 70 cm. The construction between seat and support of the legs has to be made so that this fits the longer upper leg of the patient. It is important to note that the type of upholstery also has an effect.

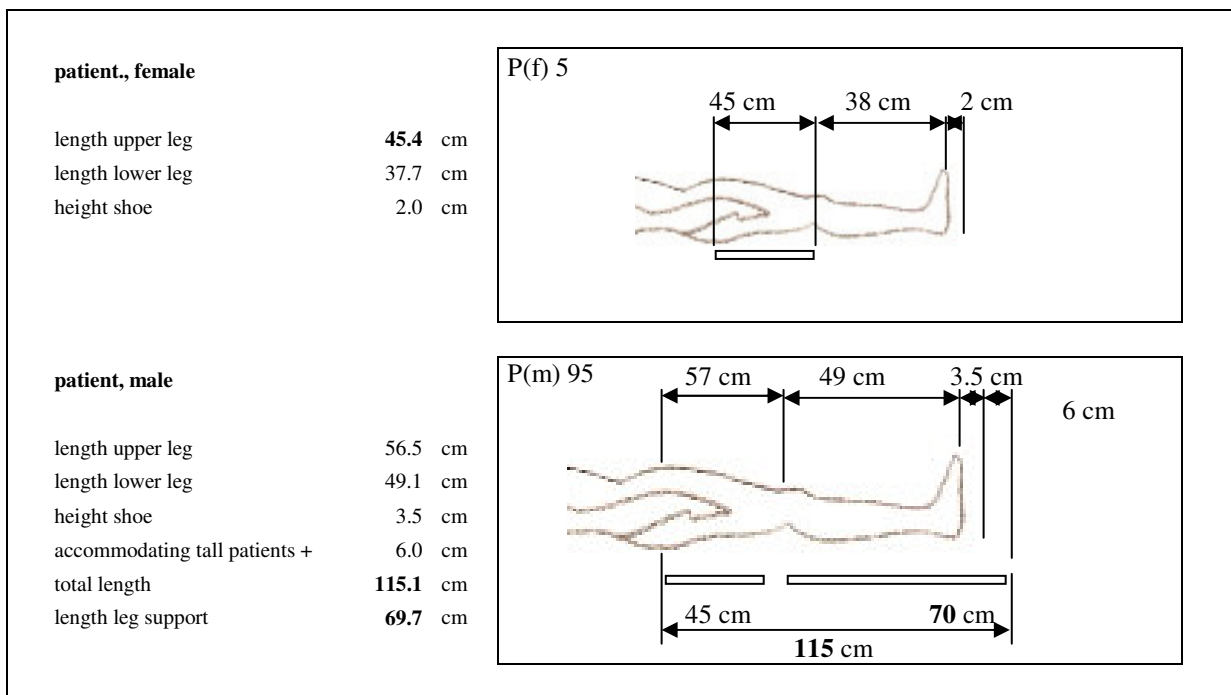

fig. 16.4 and fig. 16.5

16.6 It has also previously been determined that the height of the patient chair has to be adjustable from 35 cm to 90 cm. The total length of back and headrest is minimally 69 cm and maximally 84 cm from the SRP (see 12.8 and 12.10 together with 13.3).

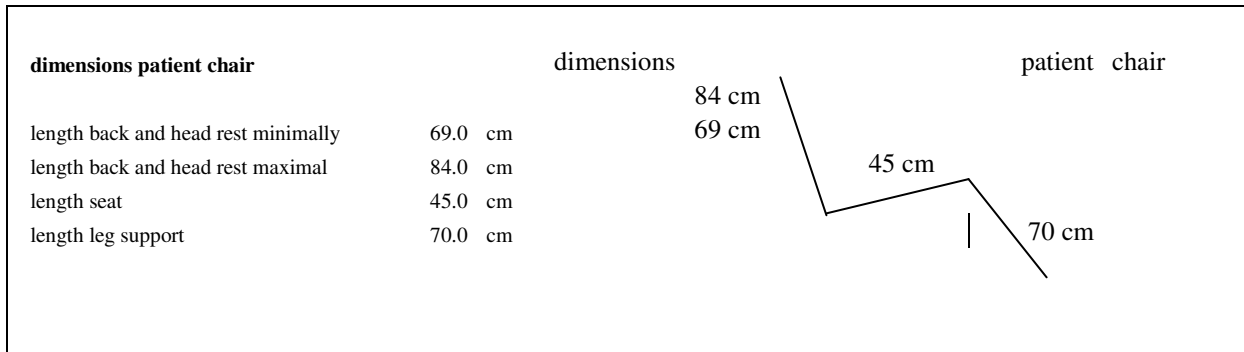

fig. 16.6

16.7 For the vertical sitting position of the patient, the back should be placed vertically, the seat horizontally and the leg support at an angle of 60° (in relation with a vertical plane).

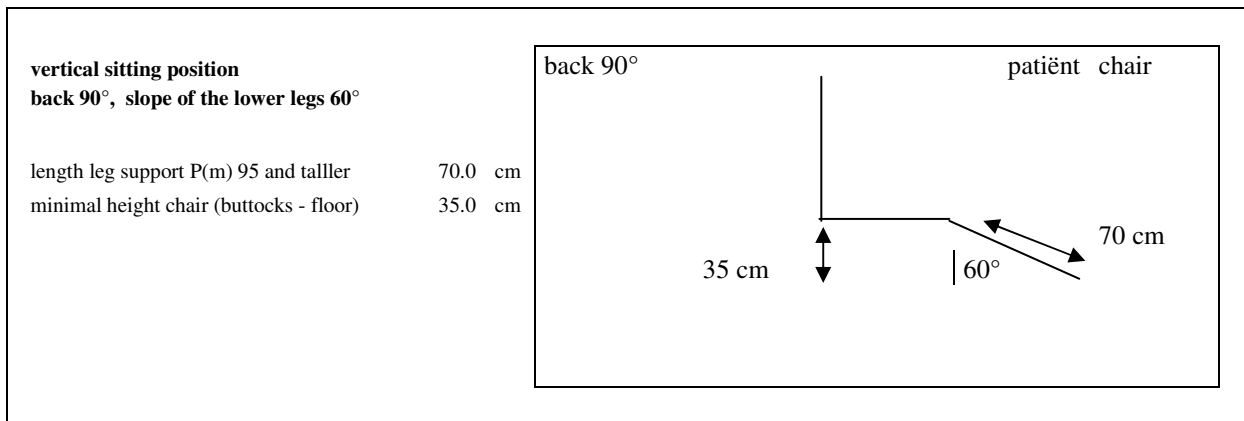

fig. 16.7

16.8 For sitting down and getting off the back should be positioned with an angle of 70-80° backward (in relation with a horizontal plane) and with the seat declining 10° backward.

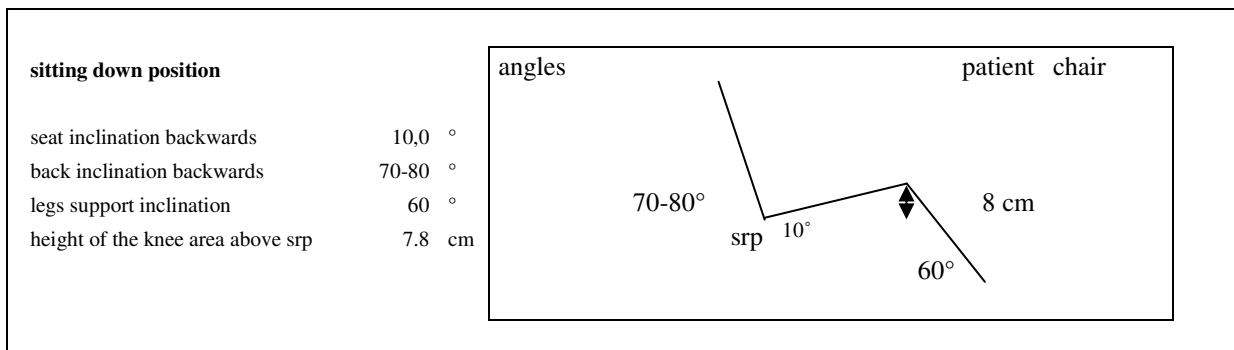

fig. 16.8

16.9 For positioning the patient horizontally the back should be positioned horizontally as should the seat and leg support. (Most people sleep on a flat bed except when this is not

possible in relation to health problems. It is important to take into consideration that, when lying on a horizontal surface, the possibility of causing problems to the blood circulation to the patient's head is avoided, moreover, this position of the body of the patient ensures that the required turnings of the head of the patient can be carried out in the best possible way. When necessary a pillow can be placed under the knees of the patient. This should only be necessary for a small group of patients. If an angle between seat and leg support cannot be avoided, the seat may be positioned with a maximum angle of  $10^\circ$  (in relation with a horizontal plane) and the leg support then has to be at an angle of  $15^\circ$  to the seat. This gives an increase of 8 cm above the horizontal plane of the back. This together with the height of the knee, 13 cm for a  $P_{(M)99}$  patient, can bring about an increase in the height of the knee of maximally 21 cm. This ensures that the nose of the patient remains above the comfort line.

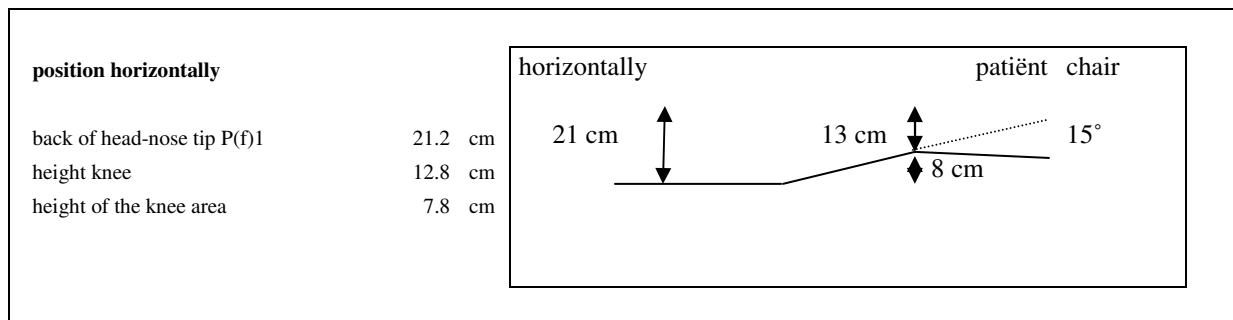

fig. 16.9

16.10 If a leg support of 70 cm is used, a  $P_{(F)5}$  dentist needs a patient chair with a minimum sitting height of 30 cm to be able to treat  $P_{(M)95}$  patients sitting vertically, however the lowest sitting height of the patient chair can be not lower than 35 cm. In other words: she is 5 cm too short to treat a  $P_{(M)95}$  patient. That means that upper and lower arms have to be lifted higher than that taken as a starting point to reach the required height. It would be better if she used a step in these situations. With other positions of the back of the patient chair no problems exist for the  $P_{(F)5}$  dentists when standing.

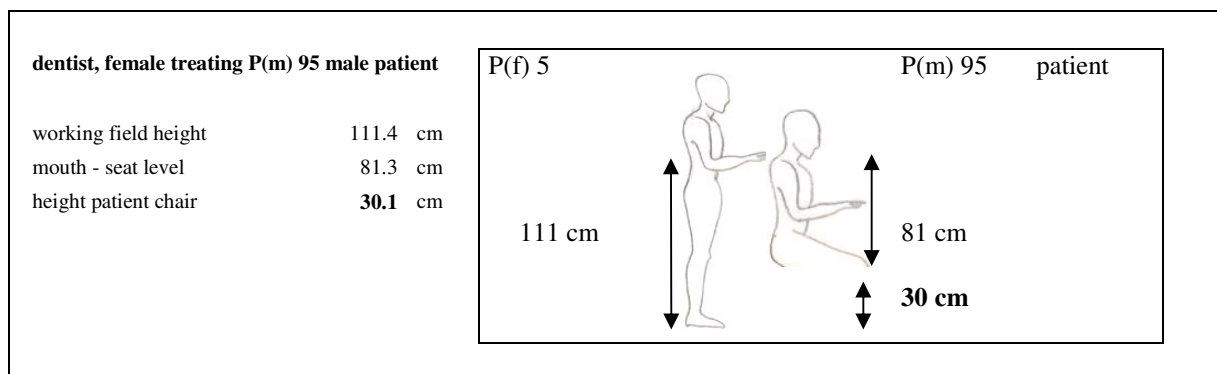

fig. 16.10

16.11 For a  $P_{(M)95}$  dentist no problems exist in treating patients sitting vertically and also sitting at an angle of  $60^\circ$  (in relation to a horizontal plane) when standing.

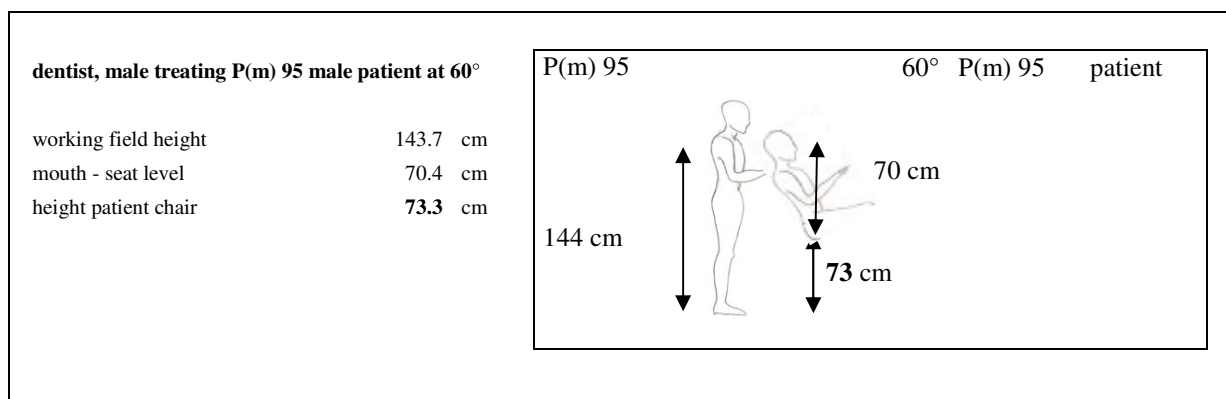

fig. 16.11

16.12 It is not possible for a P<sub>(M)</sub>95 dentist, when he stands, to treat patients sitting at an angle of 30° (*in relation with a horizontal plane*) nor patients positioned horizontally. Because he then needs a patient chair which is considerably higher than 90 cm (*103 cm*). We have no information that dentists need a horizontal position of the patient when working standing. For this purpose they will presumably work at an operating table. When a tall dentist wants to treat patients sitting at an angle of 30° (*in relation with a horizontal plane*) he may do this in a sitting working posture because he is able to sit in a high position in relation to the patient.

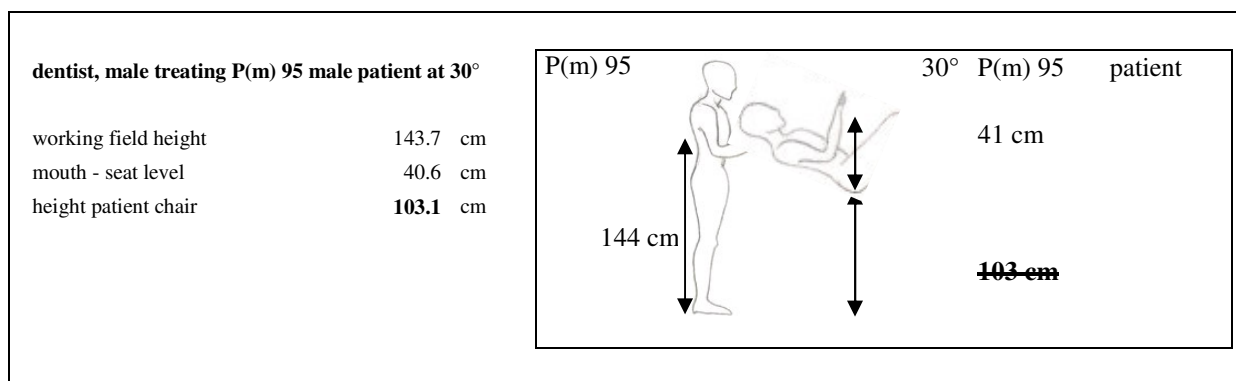

fig. 16.12

16.13 (As already mentioned) the maximal width of the patient chair is 42 cm at the top (*but well rounded off to avoid interference with the body of the dentist*), the middle of the back is 48 cm, with foldaway elbow supports at both sides of 11 cm broad and a narrowing of the underside to 43 cm. *In a correct posture the distance of the working field from the upper body can be 27 cm before the P<sub>(F)</sub>5 dentist, depending on the anatomical characteristics which may result in that the distance being a few cm's smaller. With normal conditions the contact between the upper arms and upper body can be maintained. If movements must be made, these have to be as small as possible in order to maintain good control when carrying out activities in the mouth. Lifting the arms has to be avoided as much as possible, because this requires muscle strength and that always occurs at the expense of performing activities precisely. Therefore the width of the patient chair is small, 48 cm, so that the distance to the middle of the back, and thus the middle of the mouth, is 24 cm. This results in the distance to the opposite side of the mouth being approximately 26 cm. This means that the limit for a good functioning kinematic chain will be reached or exceeded. It is, therefore, necessary for all dentists to bring the working field in the mouth into the desired position by orienting it to the viewing direction of the eyes by the 3 turnings movements of the patient's head.*



*Refraining from the proper three dimensional turning of the head will generally cause, even when working standing, an unfavourable asymmetrical posture. Despite the fact that an ideal solution will not always be possible, a reasonable solution can be attained in most circumstances*

16.14 The dimensions of the base of the chair at the back must provide enough free space for the feet of a standing dentist (*to be looked at in relation with the free space for the feet of the dentist plus foot control when seated, see 15.1*). This can presumably be achieved by rounding off the base of the chair (if present), bearing in mind that dentists sometimes stand against the seat or back of the patient chair so that space is made available for the width of an obliquely placed foot of a P<sub>(F)</sub>5 dentist: i.e. 12.7 = 13 cm.

Conclusion 1. For P<sub>(F)</sub>5 (very small) dentists limitations exist for working in a healthy posture when sitting and standing. The conditions required to reduce these limitations include: the availability of proper ergonomic equipment, the existence of reasonable circumstances and ensuring that the working field in the mouth of the patient is turned towards the viewing direction of the dentist.

Conclusion 2. A new design of the patient chair is necessary to enable dentists to work in a healthy posture (dictated by the way the body and the head of the patient have to be positioned) and for the convenience of the patient (*support of the legs, the buttocks and back, head and neck and finally the elbows*). Technically a movement of the back of the patient chair is necessary:

- to match the length of the back of the patient, by adjusting the height of the back, with a range of 15 cm, in relation to the height of the back of the patient;
- for the movement of the body backward and in a position upright via a rotation around an axis formed by the connecting line along the underside of the tuberosities ischii;

## 17. Foot control dental unit.

- 17.1 A foot control can be designed with a pedal on which the foot is placed either entirely, or partly. Placing the whole foot on the pedal causes an unfavourable load *which results in the unequal position of the right and the left foot which in turn causes an asymmetrical, harmful strain on pelvis and vertebral column*. Therefore it is necessary to place the heel on the floor so that it can support the foot, while the front part of the shoe is placed on the pedal. The foot should be raised from the heel by an angle of between 5 and 15°.
- 17.2 The length of the pedal should be 21.8 = 22 cm for the P<sub>(M)</sub>95 dentist, taking into account the fact that about 15 cm from the back of the shoe is not placed on the pedal. In practice a shorter length would be preferred.
- 17.3 The width of the pedal should be 12.7 cm taking into account the width of the shoe for a P<sub>(M)</sub>95 dentists. In practice a smaller pedal will be sufficient so 7 cm may be used.
- 17.4 A foot control can also be designed with a pedal operated by pressing on the side by movements to the right or the left.
- 17.5 Preference has to be given to this mode of operation of the pedal, since the heel rests on the floor and only small movements of maximally 15°, which require little strength, are needed.
- 17.6 A combination also exists where the pedal is placed in a certain position in relation to the desired speed and then the foot is placed on the pedal for operation. This is slightly more complicated.
- 17.7 The support for moving the foot control with the foot should be 8 cm high and 13 cm broad. (No higher because then the foot and the leg have to be lifted too high; 13 cm corresponds with the width of the foot and shoe of the P<sub>(M)</sub>95 dentist). A half open support works differently for the right and the left foot and is therefore less advisable.
- 17.8 The weight of the foot control should be designed so that the foot control can easily be repositioned, without it sliding away. In the case of a light foot control, non-slip material can be attached to it.
- 17.9 The foot control should be designed as simply as possible, there should be no more functions than necessary and it should be simple to operate. The different functions must be identifiable by easily recognizable colours and symbols. Because of hygiene requirements, more functions are being transferred onto the foot control. This should not be at the expense of practicability, particularly because the foot control is normally not visible during treatment. This results in high requirements for the positioning of the various control parts and their mode of operation.
- 17.10 A quite different design is the tube controller: a bent hose that is placed on the floor in such a way that it is possible to maintain contact when changing from one position to another. The tube control can be set up for operation with either the right or left foot so that it is not necessary to pivot the foot sideward in order to operate it.

## 18. Dental operating light.

- 18.1 A dental operating light must be able to be positioned around the head of the dentist, before and sideward so that the light beam is running parallel to the viewing direction, with a maximal deviation of approximately  $15^\circ$ , in all positions around the patient chair from which a dentist treats patients (between 8.30- 15.30 o'clock). In order to achieve this, the reach of the foreside of the dental operating light has to be so great that it can be positioned in the vertical plane of the back of the dentist. *To achieve this end in all positions around the head of the patient, and for positioning the lamp on the minimal and maximal height for P<sub>(F)</sub>5 and P<sub>(M)</sub>95 dentists, consideration may be given to fixing the dental operating light on the ceiling or the wall. Under these circumstances the length of the lamp arms can be shorter than when the lamp is fixed on the side of the unit. Furthermore, by doing so, more space at the side of the patient chair is available for parts of the equipment fixed there.*
- 18.2 A dental operating light needs 3 orthogonal axes for:
- placing a dental operating light in a adequate position near by and just above the level of the head of the dentist; on the right or left side of the head.
  - to ensure that the rectangle of the lighting field is always, and in all positions of the dental operating light, around the head of the patient, parallel with the bi-pupillary line of the eyes of the patient.
- Often the dental operating light has two axes by which the lamp can be turned around a vertical axis and forward/backward. By the third axis the lamp can be positioned obliquely with an angle of minimally about  $45^\circ$  for placing it in a manageable position on the side of the head of the dentists which is only possible with a third axis. This is necessary to have shadow free lighting in the mouth of the patient and to make it possible for the dentist to move with his head during treatment without forming shadows with his head. Otherwise the dentist is forced to place the dental operating light above the breast of the patient what is generally what happens. This causes fatigue producing shadows below the hands of the dentist, in the mouth of the patient (behind teeth, lips and cheek) and on the working field. Furthermore, the dentist then directs the opening of the mouth of the patient toward the light beam which forces him to bend forward with both head and upper body. The above described position of the lamp is required not only for working with direct vision behind and beside the patient, but also to be able to work with indirect vision with the mouth mirror directed towards the dentist.*
- 18.3 The adjustment of the lamp around 3 axes has to be made in such a way that it can easily be carried out with a balanced movement, with one handle in an as low a position as possible.

18.4 The maximal height of the dental operating light for the sitting  $P_{(M)95}$  dentist is: 177 cm. (That is the sitting height of the  $P_{(M)95}$  dentist, 164.1, + position of the lamp 10 cm higher = 174.1 cm = 174 cm, and preferably no higher to avoid a more extensive raising of the shoulder during (re)positioning of the lamp, so that the lamp will be placed at a height of 174 cm. However, taking a working height of the  $P_{(M)95}$  dentist of 107 cm into account and a focus distance of 70 cm it must be possible to place the lamp 177 cm high).

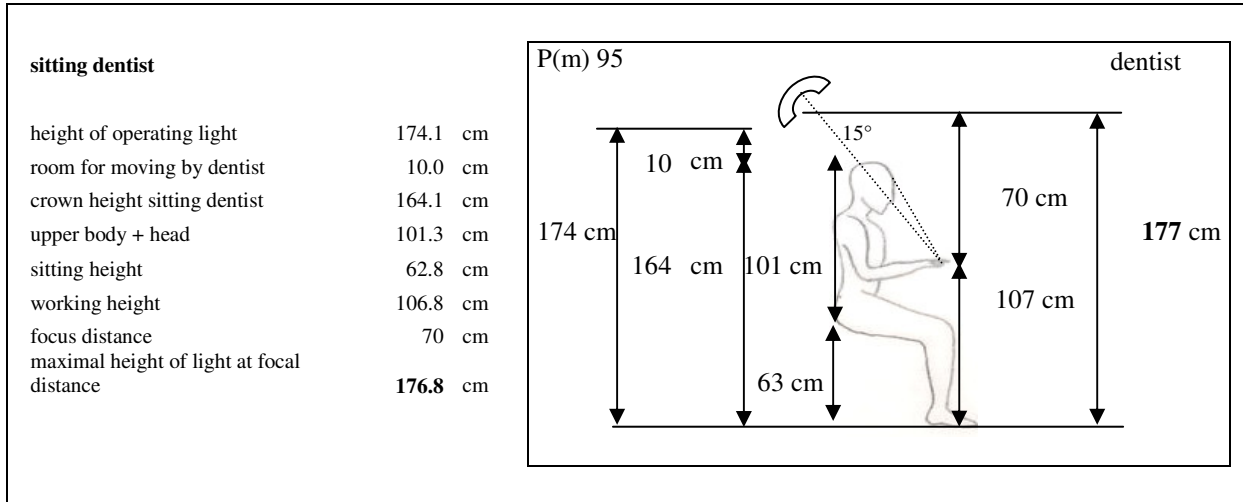

fig. 18.4

18.5 The minimal height of the dental operating light for the sitting  $P_{(F)5}$  dentists is: 139.6 cm = 140 cm. (Sitting height of  $P_{(F)5}$  dentist is 129.6 cm plus position of lamp 10 cm higher = 139.6 cm). Taking into account a working height of 78 cm and a focal distance of 70 cm it is thus possible to place the lamp at a height of 148 cm.

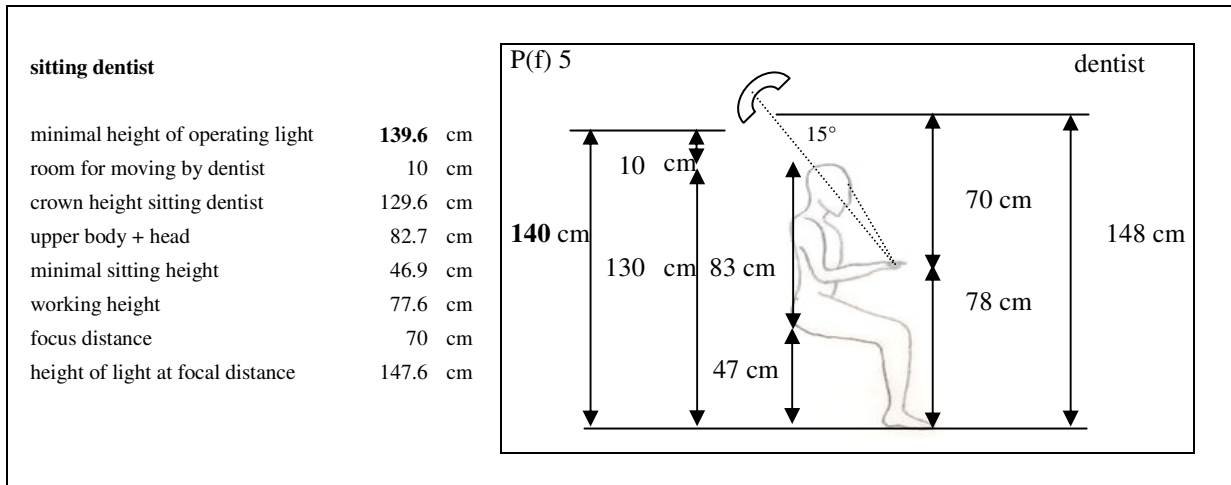

fig. 18.5

18.6 The maximal height of the dental operating for the standing  $P_{(M)95}$  dentist is: 214 cm. (Height of  $P_{(M)95}$  dentist is 195.8 cm plus height shoe 3.5 cm + position lamp 10 cm higher = 209.3 cm. However taking into account a working height for the standing  $P_{(M)95}$  dentist of 144 cm and a focus distance of 70 cm it must be possible to place the lamp at a height of 214 cm.)

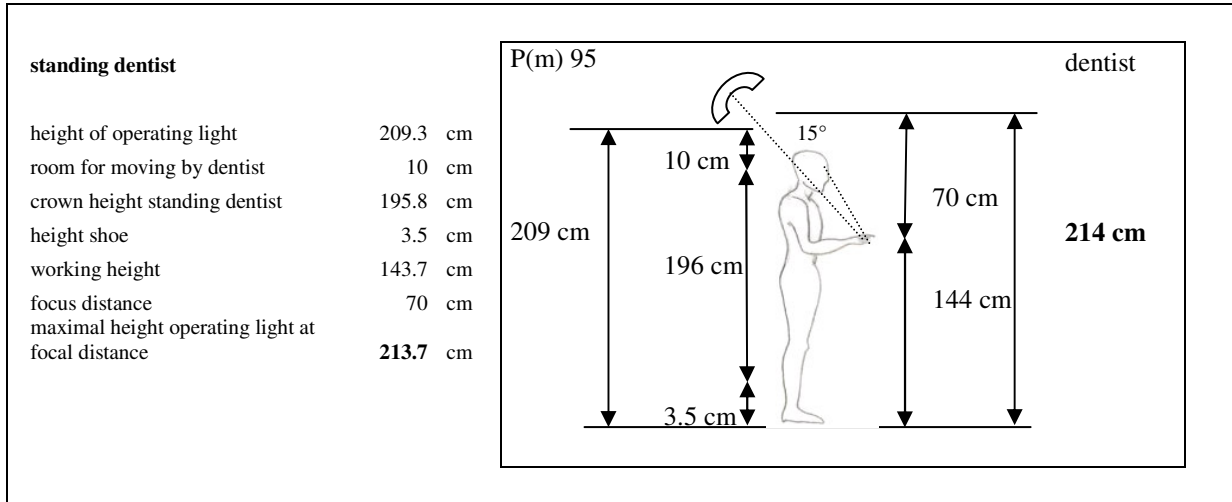

fig. 18.6

18.7 The maximum reach for the lamp behind the headrest from the Seat Reference Point, for the  $P_{(M)95}$  patient, for the range of heights is: 125 cm. (Length of back and head of the  $P_{(M)95}$  patient is 101.3 cm minus 13 cm of the back on the seat, plus body of the  $P_{(M)95}$  dentist from front to back 25 cm, plus room to manoeuvre with the lamp 12 cm. Together this is 125.3 cm. For  $P_{(M)99}$  and  $P_{(F)99}$  dentist the front to back distance is 31 cm but it can also be more. This can be accommodated by the 12 cm room to manoeuvre. To be able to position the light beam of the dental operating light parallel to the viewing direction and about 10 cm above the head, it must be possible to position the centre of the lamp in the plane along the back of the dentist. If that is the case the lamp can be placed in the desired position for all sitting positions of the dentist around the head of the patient).

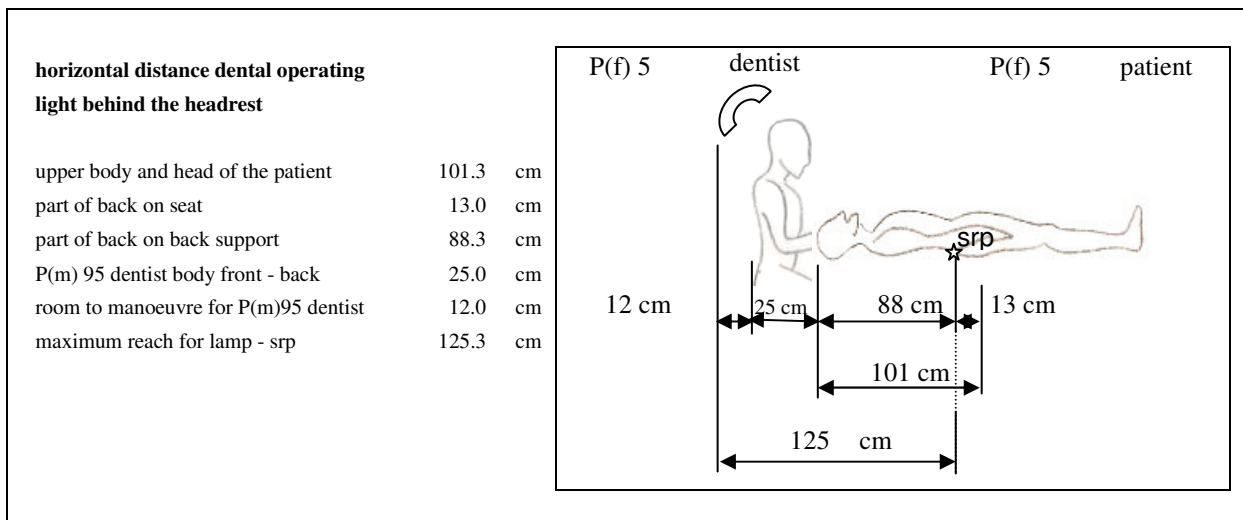

fig. 18.7

18.8 The reach of the lamp for a dentist standing before the patient is: 95 cm before the SRP (patient sitting upright with head before back 20-25 cm and distance lamp mouth patient 70 cm, being the focal distance).

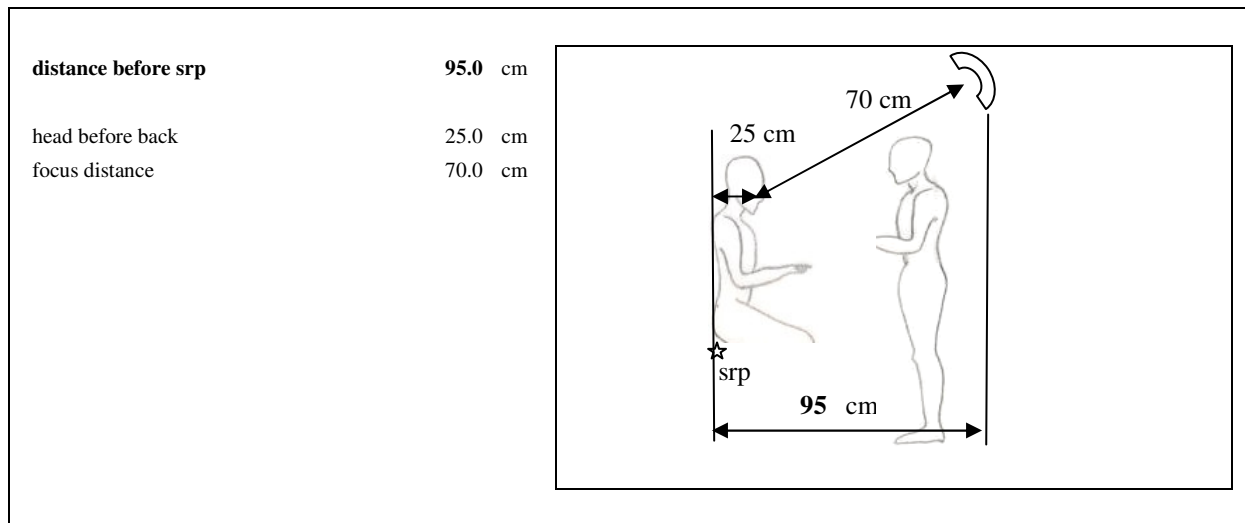

fig. 18.8

18.9 The illumination should be continuously adjustable from 8000-25000 lux. The amount of lighting must be continuously adjustable in connection with age, length of the dentist, position of the working field in the mouth, colour matching, when this is possible with the operating light etc. In order to be able to work with a luminance between 200- 2000  $\text{cd}^2$ , with an optimum of 1000  $\text{cd}^2$ . Too high an illumination level will reduce the visual acuity and cause fatiguing, glittering of instruments etc.

18.10 The colour rendering index should be 85, but if the operating light is to be used for colour matching it must be more than 90. With this in mind, a reduced light level, appropriate for colour matching, has to be used.

18.11 The colour temperature should be 5500 K. If the lamp is to be usable for colour matching, the colour temperature has also to be maintained with the lower lighting levels needed for colour matching.

## 19. Using matt surfaces.

19.1 The surfaces of dental equipment and instruments have to be matt, to avoid fatiguing glittering effects on the eyes of the dentist.

19.2 The colours used for dental equipment should be light for an optimal contrast, that means an optimal illuminance pattern to avoid more adaptation of the eyes than necessary and so prevent eye fatigue.

## 20. Positioning instruments with tubing (dynamic instruments).

- 20.1 Dynamic instruments should be positioned within:
- the field of vision, 30° right and left of the mid-sagittal or symmetrical plane of the dentist, *to avoid as far as possible the fatiguing accommodation and adaptation of the eyes outside the field of vision;*
  - a reach of 30-40 cm from the dentist, to avoid undesirable movements of arms and shoulders in the working positions from 8.30 to 12.30 o'clock for right handed dentists; for left handed dentists from 11.30 to 15.30 o'clock.
- 20.2 The instrument console needs to have an adequate reach so that it is possible to place the tubing with the attached instruments within the direction of grasp, and thereby prevent sideward movement of the tubing which results in traction.
- 20.3 Dynamic instruments should be positioned within an angle of between 30-60° with regard to the mouth of the patient (or as near to this as possible), *this ensures a favourable, natural way of reaching for the instruments by the dentist, without involving movements of the shoulder.* If a dental assistant uses the multifunction syringe or transfers instruments to the dentist the positioning of the instruments will need to be adjusted.
- 20.4 The instrument console needs to be able to be moved, with the instruments in the desired position, with little effort and without the console slipping away, *otherwise the instruments will be positioned unfavourably and this will inevitably result in the dentist having to make undesirable, twisting movements when using the dynamic instruments.*
- 20.5 Dynamic instruments associated with a front delivery system, here the handpiece tubing has to be balanced in such a way that no traction is felt. Length (about 80 cm) and height of the tubing have to match the desired reach of the instruments when these are being used. Instead of bolting the handpiece tubing, attachment has to be done in such a way that no traction or other disturbing forces are felt during use or as a result of designing an unbalanced system.
- 20.6 Dynamic instruments should hang down with an angle of 45° in relation to a vertical plane and at least 6 cm, but preferably about 10 cm, should be free hanging to enable them to be adequately grasped (*when the instruments are free hanging by a length of 10 cm the instrument can be gripped at once with the full hand. When the instruments are attached more upright than the recommended 45°, one is forced to reach further with the hand between the instruments to grasp them.*

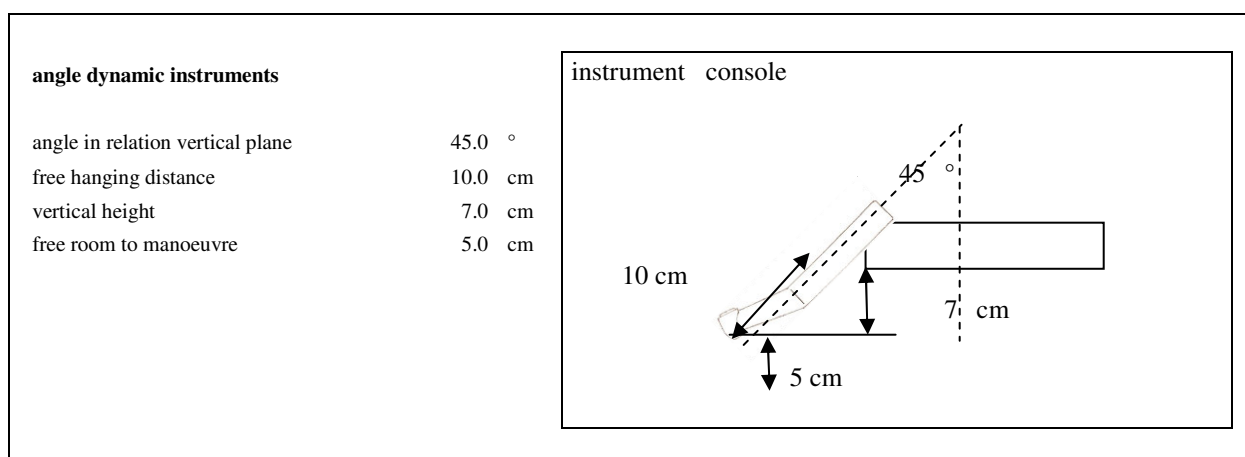

fig. 20.6 and fig. 20.7

20.7 This means that the vertical distance of the head of the instrument below the instrument console is approximately 7 cm, so as close as possible above the working height, when treating a horizontally positioned patient.

20.8 When the dentist is seated the dynamic instruments have to be positioned vertically, as close as possible, to the working area. This is about 5 cm above the working height in the mouth, i.e. minimally 78 cm and maximally 107 cm.

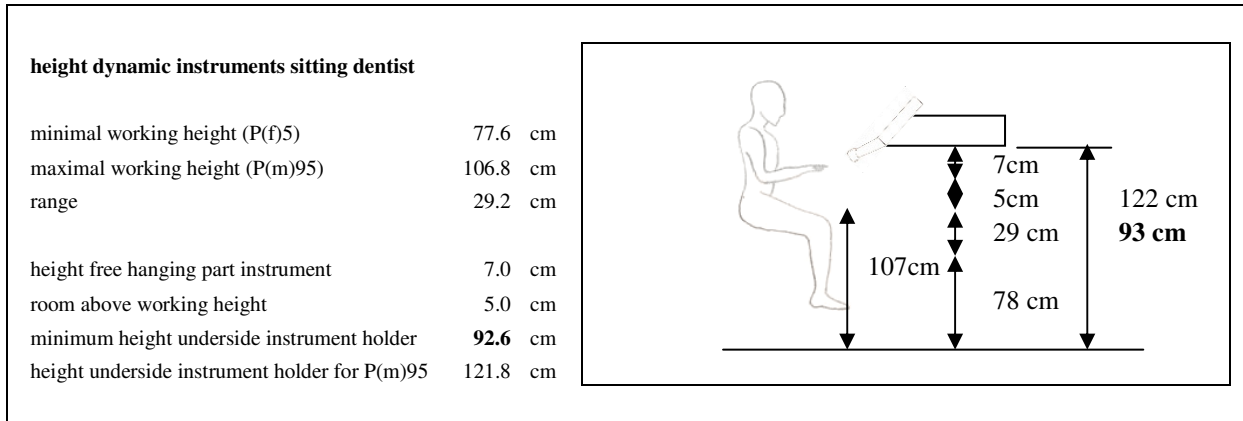

fig.20.8

20.9 The working height for a P<sub>(M)</sub>95 standing dentist is 143.7 = 144 cm.

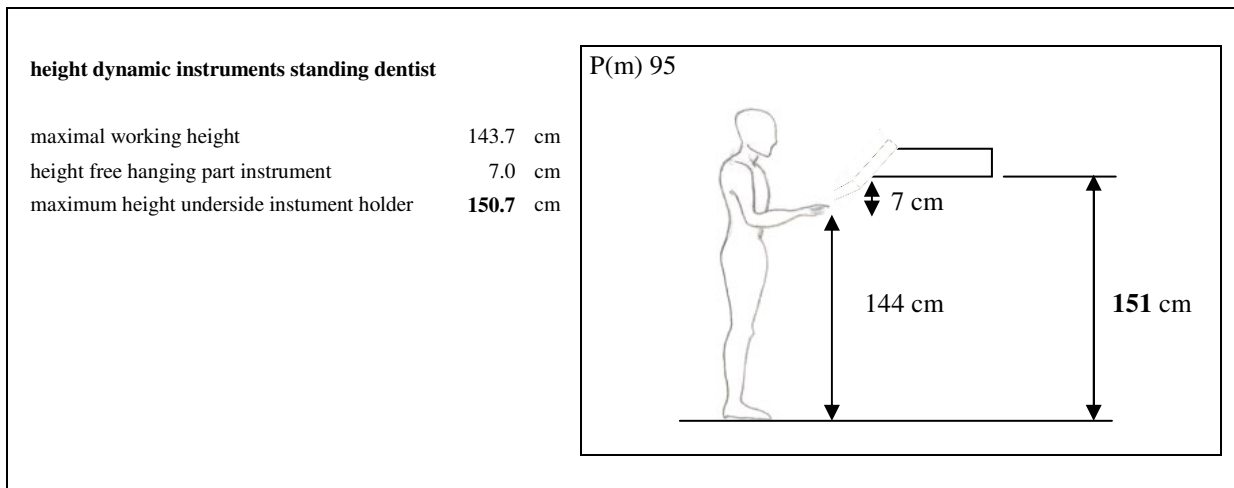

fig. 20.9

20.10 The distance between dynamic instruments should be minimally, about 6 cm (*measured from the middle of the instruments*) and they should be positioned in such a way that damage caused by the sharp ends of the instruments, can be avoided.

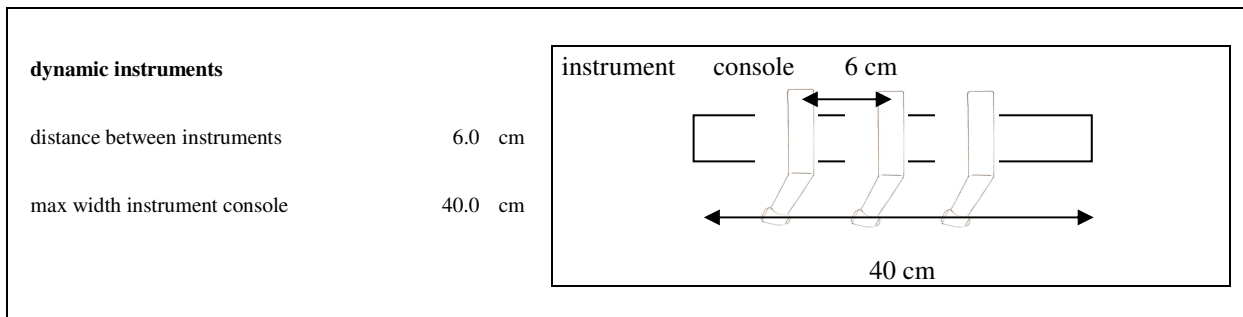

fig. 20.10



- 20.11 Too broad a range of instruments should be avoided because then the dentist is forced to carry out undesirable movements in order to grasp instruments towards the outer side of the instrument console. These instruments also fall outside the field of vision, adding to the undesired movements which then have to be carried out in order to use them. An instrument console with a width of about 40 cm appears to be a good solution.
- 20.12 The underside of the instrument console should be flat, so that this can be positioned about 10 cm above the breast of the patient.
- 20.13 The control panel for operating different functions, e.g. the patient chair, can be best positioned at the side of the instrument console, nearby the working height (*for an easy reach*); and it should preferably be able to swivel so that one is able to look upon it perpendicularly both when working sitting and standing.

## 21. Positioning hand instruments for the dentist.

- 21.1 It should be possible to position the tray for hand instruments at a distance of 20 to maximally 25 cm of the body of the dentist at a minimum working height of 77 cm and a maximum working height of 111 cm.
- 21.2 The distance from the underside of the instrument console to the tray has to be about 9-10 cm.
- 21.3 The tray holder has to be attached to the unit via firstly, a horizontal arm with a swivel coupling that is placed directly below the console. Further, the arm must be horizontal over most of its length (*to avoid contact with the breast of the patient*) and only bend downwards directly before a second swivel coupling to which a short arm is attached. The tray holder then requires to be placed upon this short, approximately 5 cm, second arm which also provides a sliding mechanism so that the tray holder can be placed in the required position. This system results in the maximal flexibility for the positioning of the tray holder. *The problem is that when using dynamic instruments from the instrument console, space is needed to grasp these instruments. The hand instrument tray therefore needs to be in such a position that it does not interfere with this process. Furthermore, hand instruments need to be positioned a little lower than the elbows to ensure that they are at the best place to pick them up. But then the relation with the working height of the dynamic instruments on the console is wrong and the tray has then to be positioned away, and to the side of the body of the patient (and then the instrument console has to be placed too far to the right). Otherwise the hand instrument tray could be placed under the console, and at the correct height above the patient, but this makes it necessary to position the dynamic instruments too high. This complex situation makes it necessary to construct an instrument console very accurately; with the dynamic instruments hanging down and a turning arm for the tray holder behind these, directly below the console. Further, it is necessary to provide a means of reach and a swivelling mechanism for the tray together with a maximal ability to change the position of the tray in the tray holder (all together providing the required distance from the dentist). Finally the height of the tray below the underside of the console needs to be designed to allow connection with, but not interference with the dynamic instruments hanging down from the console.*

The most ideal solution is a height adjustable tray holder with three axes. When however, a fixed height is utilized, the upper side of the tray holder can be placed circa 10 cm below the underside of the instrument console. In order that the tray with hand instruments can be positioned about 4-5 cm below the dynamic instruments with bur etc. This height is also necessary in order to be able to grip the hand instruments correctly without lifting the upper arm.

The tray is fixed in the centre below the instrument console with a horizontal arm just below the underside of the instrument console (*to avoid contact with the breast of the patient*). This arm is bent at the end, nearby the swivelling arm/holder, itself of about 5 cm, for the tray holder attached to this by a mechanism which allows the position of the tray to vary horizontally. The first arm, fixed below the instrument console, can reach up to 10 cm sideward of the console at both sides (*for use of the tray at both sides of the console. This arm is bent at the end to avoid contact with the hand when grasping dynamic instruments, as the tray is positioned just far enough below the hanging dynamic instruments of the console. N.B. Any further handle designed to aid the positioning of the console must not interfere with the positioning of the tray and/or its holder*)

## **22. Positioning instruments for the dental assistant.**

- 22.1 The instruments for suction and, where needed, other instruments with tubing used by the dental assistant, must be positioned as far as possible toward the front of the upper body of the dental assistant, when positioned at her left side (in the situation with a right handed dentists), at a minimum working height of 78 cm and a maximum working height for a  $P_{(F)95}$  dental assistant of  $116.2 = 116$  cm, for use in a sitting and standing position. *(The length of a  $P_{(F)95}$  dental assistant corresponds with the length of a  $P_{(M)50}$  dental assistant. An oblique position of the instruments, about  $45^\circ$  is desired or when possible, the instruments should hang down to allow a natural way of grasping.*
- 22.2 When these instruments are also used by the dentist the reach must fulfil the requirement of being at a distance of 30-40 cm in the different working positions of the dentist *(so positioned next to the head of the patient).*
- 22.3 The form of holders for the instruments has to be ample funnel-shaped so that the instruments can easily be taken out and replaced.
- 22.4 Even when the instruments for the dental assistant come from the rear *(right side of the dental assistant)* the same requirements as mentioned above apply in principle.
- 22.5 The best place for the tray with instruments for the dental assistant is as yet unknown: *We need documented data about the best way the tray with instruments for the dental assistant should be placed*
- 22.6 An alternative could be the body tray that is positioned on the breast of the patient just before the mouth to be used by not only the dentist but also the dental assistant.

## **23. Positioning spittoon.**

- 23.1 The spittoon should be placed at the side of the patient chair and should be movable so that the dental assistant has space to sit and so that there is room available for the instruments of the dental assistant unit, coming from her left side (when working with a right handed dentists). Space for the left upper leg of the dental assistant has to reach to about 15 cm behind the SRP for the  $P_{(F)5}$  lying patient *(previously we have calculated that from the rear of the headrest, about 50 cm below the back is needed for the upper legs of dentist and dental assistant).*

#### **24. Principles for dynamic instruments to be used separately or in a unit.**

An analysis is required of all instruments that may be used by a dentist, connected with the unit or separate from it. The type of instruments which form a part of the instrument console will depend on the kind of oral health care provided by the dentist and the use of the equipment by different (part-time) dentists. A modular system is necessary for an easy change of instruments. Additionally, possibilities for using more instruments without broadening the width of the instrument console have to be explored. For example, by using instruments attached in different ways depending on whether these are used with the pen-grip or the palm-grip.

A separate analysis is required to assess the use of multimedia, this should include: which devices will be used, what will be an integral part of the unit and what will be used separately, and in which way used: e.g. for data, visual representations, health information and education and eventually entertainment.

Finally it will be necessary to consider the requirements regarding the instruments themselves with respect to diameter, form, texture, matt surface, etc.

#### **25. Use equipment by right and left handed dentists.**

*By fixing the dental operating light on the ceiling or the wall - whenever possible - space becomes available at the side of the patient chair that provides more room to manoeuvre around the patient chair and for using dental equipment at both sides of the patient chair. Criteria have to be further worked out on the basis of empirical data.*

## 26. Screen (visual display terminal, VDT) related to dental equipment.

- 26.1 Functions of the screen: can be used for operation of the equipment, X-rays, imaging, patient information etc.
- 26.2 When positioning the screen 3 aspects are important.
- Looking distance and height of letters/ size of details.
  - Height of the screen in relation with the height of the eyes of the dentist.
  - Reflection, contrast and type of screen.
- 26.3 A relation exists between looking distance and the required height of symbols. For observing details the following rule of thumb can be used. If, at a looking distance of 0,5 m letters and details can be observed well, e.g. from digital X rays, then the same magnification relation between letters and other images can be operated.

Looking distance	Minimal height symbols	Relation stokdike and height letters/symbols
0,5 metre	2,5 mm	1:6 tot 1:10
1 metre	5 mm	1:6 tot 1:10
5 metre	25 mm	1:6 tot 1:10

Size screen	Recommended looking distance
14 inch	50-70 cm
15 inch	55-75 cm
17 inch	60-85 cm
19 inch	70-95 cm
21 inch	75-105 cm

- 26.4 To ensure a relaxed way of looking, in which the spinal column can remain in a neutral posture and the eyeball hardly needs to rotate, the following position of the screen needs to be arranged. Starting from a correct sitting posture, a horizontal line is drawn from the eyes toward the topmost line of the text on the screen. This determines the height of the screen. The dentist then needs to position the screen in his symmetrical plane, taking into account his working position. So that his mid-sagittal line corresponds with the middle vertical line of the screen.
- The height of the topmost line usually results in a height for the screen of between 119cm and 152 cm, this being the height of the eyes of the P<sub>(F)</sub>5 and the P<sub>(M)</sub>95 dentist respectively, when sitting with an angle of 110° between lower and upper legs.
- 26.5 Reflection can be avoided by using the right fittings with high frequency neon lamps and turning the screen as vertically as possible. A flat screen should be used in relation to a dental unit in connection with its size, it also gives less heat production.
- In order to provide adequate observation, a good contrast is required on the screen. The relation 10 : 1 can be used; below 1 : 3 the legibility clearly decreases. The use of colour will never improve the legibility. When using colours it is necessary to optimise the contrasts.

## **27. Infection prevention.**

- 27.1 The quality of water within dental equipment has to be guaranteed in relation to disinfection by incorporating good design and using all measures necessary to this end, whilst the dentist is responsible for the quality of the water supply to the unit.
- 27.2 The system should function (semi)-automatically when the equipment is not in use (thermal/physical disinfection is preferred above chemical disinfection as a consequence of the disadvantages of chemical disinfection *such as resistance, favouring one type of micro-organism over another and legislation in relation to health and safety*).
- 27.3 Operation of the system must be easy for both dentist and dental assistant.
- 27.4 The dentist must be informed about how he can monitor water quality with dip slides.
- 27.5 Surfaces of equipment need to be smooth, without joints, sharp transitions or edges and easily accessible for cleaning and disinfection.

## **28. Equipment not fulfilling ergonomic requirements fully.**

We recommend that the differences between equipment that does not comply with the recommendations outlined in this document are always stated by the manufacturer e.g. the height of the chair, working heights of instruments, reach for instruments etc. Information about the limitations has to be available for both dentists and oral health institutions. This will enable them to judge the properties of the equipment with respect to their own individual requirements e.g. a tall dentist will not be interested in equipment that does not fulfil the top end of the requirements, but if this equipment fulfils the lower end of the requirements, a short dentist would probably find it preferable. In this way each dental practice can verify whether equipment fits the required characteristics to enable their staff to work without damaging their health.

It is clear that only a front delivery system enables it to be possible to work fully in a healthy way. For other categories of equipment the ergonomic limitations and possibilities have still to be worked out in more detail. When this is also completed the dentist can obtain all the information he needs for a well considered judgement of the available equipment, and so can determine what he wants. That will always, rightly, remain his or her decision.

Prof Oene Hokwerda, dentist and dental ergonomist.  
Vice-President European Society of Dental Ergonomics (ESDE).  
Academic Center Oral Health Groningen (ACMG). Universiy Medical Center Groningen (UMCG), the Netherlands.  
[oene.hokwerda@home.nl](mailto:oene.hokwerda@home.nl)

Joseph Wouters, registered occupational assessor and ergonomist.  
Bureau for work capability and incapacity, Leusden, the Netherlands.  
[j.wouters@terzet.nl](mailto:j.wouters@terzet.nl)

Rolf de Ruijter, dentist and in training as dental ergonomist.  
AMCG of the UMCG, Groningen, the Netherlands.  
[r.a.g.de.ruijter@med.umcg.nl](mailto:r.a.g.de.ruijter@med.umcg.nl)

Sandra Zijlstra-Shaw B.D.S., dentist.  
AMCG of the UMCG, Groningen, the Netherlands.  
[s.shaw@med.umcg.nl](mailto:s.shaw@med.umcg.nl)

## Appendix.

### Survey subjects for which more empirical data are required.

This list has been drawn up in relation to “Ergonomic requirements for dental equipment” and consists of subjects for which more data are required.

1. Functioning of the kinematic chain for all sizes of dentists.
2. Relation of the viewing direction with the position of the working field.
3. Further detailed study of different body dimensions.
4. Limitations for a small dentist, working in a sitting position and standing posture.
5. Posture problems of female dentists.
6. Chair used for a vertical position of the patient for some dental treatments, especially the position of the legs.
7. Armrest working stool dentist.
8. Requirements for the extent of the flexibility of the upholstery of working stool and patient chair.
9. Individually adjustable lordosis support in patient chair back (regarding place and form).
10. Use of the foot control: which functions can be operated by means of a foot control with respect to visibility and mode of operation.
11. Use of the type and number of instruments on a instrument console, depending on the kind of dental treatment and depending on the use of equipment by different dentists. Further the maximum width of the instrument console and the maximum possible number of instruments. How to change instruments quickly for use of equipment by different dentists etc. The use of modules for instruments.
12. Tray positioning for the (solo) dentists, in relation with the instrument console.
13. Positioning of suction for dental assistants.
14. Positioning tray with instruments for dental assistants (in relation with 11).
15. The use of a screen on dental equipment in relation with the required functions.
16. Principles of designing dynamic instruments.
17. Principles of the use of dental equipment by right and left handed dentists using the experiences of dentists.